

**DAIKIN**

# OPERATION MANUAL

---

## **VRV** SYSTEM Inverter Air Conditioners

---

English

Français

Español

### MODELS

#### Ceiling-mounted Duct type

**FXMQ07PVJU**

**FXMQ09PVJU**

**FXMQ12PVJU**

**FXMQ18PVJU**

**FXMQ24PVJU**

**FXMQ30PVJU**

**FXMQ36PVJU**

**FXMQ48PVJU**

Thank you for purchasing this Daikin air conditioner. Carefully read this operation manual before using the air conditioner. It will tell you how to use the unit properly and help you if any trouble occurs. This manual explains about the indoor unit only. Use it along with the operation manual for the outdoor unit. After reading the manual, file it away for future reference.

Nous vous remercions pour votre acquisition de ce système de climatisation Daikin. Lisez attentivement ce manuel avant d'utiliser le climatiseur. Il vous expliquera comment vous servir correctement de l'appareil et vous guidera en cas de problème. Ce manuel ne décrit que l'unité intérieure. Utilisez-le avec le manuel de l'unité extérieure. Lorsque vous aurez lu le manuel, rangez-le afin de pouvoir vous y référer ultérieurement.

Le agradecemos la compra de este acondicionador de aire Daikin. Lea cuidadosamente el manual de funcionamiento antes de utilizar el acondicionador de aire. Dicho manual le indicará cómo utilizar adecuadamente la máquina y le ayudará en caso de avería. Este manual describe sólo la unidad interior. Utilice conjuntamente con el manual de instrucciones de la unidad exterior. Después de leer el manual, consérvelo para consultas futuras.

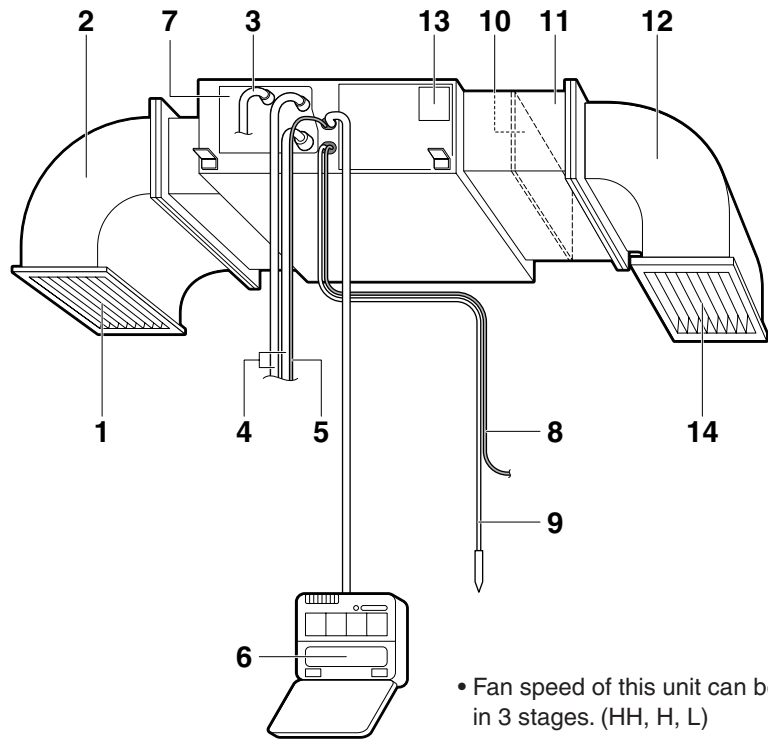



## SAFETY CONSIDERATIONS

Read these **Safety Considerations for Operations** carefully before installing air conditioning equipment. After completing the installation, make sure that the unit operates properly during the startup operation. Instruct the customer on how to operate and maintain the unit.

Inform customers that they should store this Operation Manual with the Installation Manual for future reference.

Meanings of **DANGER**, **WARNING**, **CAUTION**, and **NOTE** Symbols:

 **DANGER** ..... Indicates an imminently hazardous situation which, if not avoided, will result in death or serious injury.

 **WARNING** ..... Indicates a potentially hazardous situation which, if not avoided, could result in death or serious injury.

 **CAUTION** ..... Indicates a potentially hazardous situation which, if not avoided, may result in minor or moderate injury. It may also be used to alert against unsafe practices.

 **NOTE** ..... Indicates situations that may result in equipment or property damage accidents only.

---

### **DANGER**

- Do not install the unit in an area where flammable materials are present due to risk of explosion resulting in serious injury or death.
- Any abnormalities in the operation of the air conditioner such as smoke or fire could result in severe injury or death. Turn off the power and contact your dealer immediately.
- Refrigerant gas may produce toxic gas if it come in contact with fire, such as from a fan, heater, stove, or cooking device. Exposure to this gas could cause severe injury or death.
- For refrigerant leakage, consult your dealer. Refrigerant gas is heavier than air and replaces oxygen. A massive leak could lead to oxygen depletion, especially in basements, and an asphyxiation hazard could occur leading to serious injury or death.
- If equipment utilizing a burner is used in the same room as the air conditioner, there is the danger of oxygen deficiency which could lead to an asphyxiation hazard resulting in serious injury or death. Be sure to ventilate the room sufficiently to avoid this hazard.
- Safely dispose of the packing materials. Packing materials, such as nails and other metal or wooden parts, may cause stabs or other injuries.
- Tear apart and throw away plastic packaging bags so that children will not play with them. Children playing with plastic bags face the danger of death by suffocation.

---

### **WARNING**

- Contact your dealer for repair and maintenance. Improper repair and maintenance may result in water leakage, electric shock, and fire. Only use accessories made by Daikin that are specifically designed for use with the equipment and have them installed by a professional.
- Contact your dealer to move and reinstall the air conditioner. Incomplete installation may result in water leakage, electric shock, and fire.
- Never let the indoor unit or the remote controller get wet. Water can cause an electric shock or a fire.
- Never use flammable spray such as hair spray, lacquer, or paint near the unit. Flammable spray may cause a fire.
- When a fuse blows out, never replace it with one of incorrect ampere ratings or different wires. Always replace any blown fuse with a fuse of the same specification.
- Never remove the fan guard of the unit. A fan rotating at high speed without the fan guard is very dangerous.
- Never inspect or service the unit by yourself. Contact a qualified service person to perform this work.
- Turn off all electrical power before doing any maintenance to avoid the risk of serious electric shock; never sprinkle or spill water or liquids on the unit.
- Do not touch the switch with wet fingers. Touching a switch with wet fingers can cause electric shock.
- Do not allow children to play on or around the unit to prevent injury.
- The heat exchanger fins are sharp enough to cut. To avoid injury wear gloves or cover the fins while working around them.
- Do not put a finger or other objects into the air inlet or air outlet. The fan is rotating at high speed and will cause injury.
- Check the unit foundation for damage on a continuous basis, especially if it has been in use for a long time. If left in a damaged condition the unit may fall and cause injury.
- Placing a flower vase or other containers with water or other liquids on the unit could cause a shock or fire if a spill occurs.
- Do not touch the air outlet or horizontal blades while the swing flap is in operation because fingers could get caught and injured.
- Never touch the internal parts of the controller. Do not remove the front panel because some parts inside are dangerous to touch. To check and adjust internal parts, contact your dealer.
- Be sure to establish an earth. Do not earth the unit to a utility pipe, arrester, or telephone earth. Incomplete earth may cause electrical shock, or fire. A high surge current from lightning or other sources may cause damage to the air conditioner.
- Be sure to install an earth leakage breaker. Failure to install an earth leakage breaker may result in electric shocks, or fire.

—  CAUTION —

- Do not use the air conditioner for any other purposes other than comfort cooling or heating. Do not use the unit for cooling precision instruments, food, plants, animals or works of art.
- Do not place items under the indoor unit as they may be damaged by condensates that may form if the humidity is above 80% or if the drain outlet gets blocked.
- Before cleaning, stop the operation of the unit by turning the power off or by pulling the supply cord out from its receptacle. Otherwise, an electric shock and injury may result.
- Do not wash the air conditioner with excessive water. An electric shock or fire may result.
- Avoid placing the controller in a spot splashed with water. Water entering the controller may cause an electric shock or damage the internal electronic parts.
- Do not operate the air conditioner when using a roomfumigation type of insecticide. Failure to observe this could cause the chemicals to be deposited in the unit and can endanger the health of those who are hypersensitive to chemicals.
- Do not turn off the power immediately after stopping operation. Always wait for at least five minutes before turning off the power. Otherwise, water leakage may occur.
- The appliance is not intended for use by young children or infirm persons without supervision.
- The remote controller should be kept away from children so they cannot play with it.
- Consult with the installation contractor for cleaning.
- Incorrect cleaning of the inside of the air conditioner could make the plastics parts break and cause water leakage or electric shock.
- Do not touch the air inlet or aluminum fin of the air conditioner as they can cut and cause injury.
- Do not place objects in direct proximity of the outside unit. Do not let leaves and other debris accumulate around the unit. Leaves are a hotbed for small animals which can enter the unit. Once inside the unit, animals can cause the unit to malfunction, and cause smoke or fire when they make contact with electrical parts.

—  NOTE —

- Never press the button of the remote controller with a hard, pointed object. The remote controller may be damaged.
- Never pull or twist the electric wire of the remote controller. It may cause the unit to malfunction.
- Do not place appliances that produce open flames in places that are exposed to the air flow of the unit or under the indoor unit. It may cause incomplete combustion or deformation of the unit due to the heat.
- Do not expose the controller to direct sunlight. The LCD display can become discolored and may fail to display the data.
- Do not wipe the controller operation panel with benzene, thinner, chemical dust cloth, etc. The panel may get discolored or the coating can peel off. If it is heavily dirty, soak a cloth in water-diluted neutral detergent, squeeze it well and wipe the panel clean. Then wipe it with another dry cloth.

- Dismantling of the unit, disposal of the refrigerant, oil, and additional parts, should be done in accordance with the relevant local, state, and national regulations.
- Operate the air conditioner in a sufficiently ventilated area and not surrounded by obstacles. Do not use the air conditioner in the following places.
  - a. Places with a mist of mineral oil, such as cutting oil.
  - b. Locations such as coastal areas where there is a lot of salt in the air.
  - c. Locations such as hot springs where there is a lot of sulfur in the air.
  - d. Locations such as factories where the power voltage varies a lot.
  - e. In cars, boats, and other vehicles.
  - f. Locations such as kitchens where oil may splatter or where there is steam in the air.
  - g. Locations where equipment produces electromagnetic waves.
  - h. Places with an acid or alkaline mist.
  - i. Places where fallen leaves can accumulate or where weeds can grow.
- Take snow protection measures. Contact your dealer for the details of snow protection measures, such as the use of a snow protection hood.
- Do not attempt to do electrical work or grounding work unless you are licensed to do so. Consult with your dealer for electrical work and grounding work.
- Pay Attention to Operating Sound. Be sure to use the following places:
  - a. Places that can sufficiently withstand the weight of the air conditioner yet can suppress the operating sound and vibration of the air conditioner.
  - b. Places where warm air from the air outlet of the outside unit or the operating sound of the outside unit does not annoy neighbors.
- Make sure that there are no obstacles close to the outside unit. Obstacles close to the outside unit may drop the performance of the outside unit or increase the operating sound of the outside unit.
- Consult your dealer if the air conditioner in operation generates unusual noise.
- Make sure that the drainpipe is installed properly to drain water. If no water is discharged from the drainpipe while the air conditioner is in the cooling mode, the drainpipe may be clogged with dust or dirt and water leakage from the indoor unit may occur. Stop operating the air conditioner and contact your dealer.

## NAME OF PARTS

Refer to figure 1 on page [1]

1. Air outlet (Field supply)
2. Exhaust duct (Field supply)
3. Drain pipe
4. Connection piping
5. Transmission wiring
6. Remote controller (Field supply)
7. Drain discharge device (built-in)  
Discharges indoor moisture removed during cooling operation.
8. Power line

9. Ground wiring  
This wire releases electricity from the indoor unit to the ground in order to prevent electric shock or fire.
10. Air filter (inside filter chamber) (Field supply)
11. Suction filter chamber (Field supply)
12. Suction duct (Field supply)
13. Machine nameplate  
The nameplate is imprinted with the machine name and specifications.
14. Suction grille (Field supply)

## MAINTENANCE

### WARNING

- **Only a qualified person is allowed to perform maintenance without daily maintenance.**
- **Before touching any of connection wirings, be sure to turn off all power supply switches.**
- **Do not use flammable materials (e.g., hairspray or insecticide) near the product.**  
**Do not clean the product with organic solvents such as paint thinner.**  
The use of organic solvents may cause crack damage to the product, electric shocks, or fire.
- **Contact professional personnel about attachment of accessories and be sure to use only accessories specified by the manufacturer.**  
If a defect results from your own workmanship, it may result in water leaks, electric shock or fire.

### CAUTION

- **Before cleaning, be sure to stop unit operation, turn the breaker off or remove the power cord.**  
Otherwise, an electric shock and injury may result.
- **Do not wash the air conditioner with water, as this may result in electric shocks or fire.**
- **Consult your dealer regarding cleaning the inside of the air conditioner.**  
Improper cleaning may cause breakage of plastic parts, water leakage and other damage as well as electric shocks.
- **Watch your steps at the time of air filter cleaning or inspection.**  
High-place work is required, to which utmost attention must be paid.  
If the scaffold is unstable, you may fall or topple down, thus causing injury.

## HOW TO CLEAN THE AIR FILTER

(The air filter is a field supply.)

Clean the air filter when the display shows “” (TIME TO CLEAN AIR FILTER).

- This message is displayed once the unit has operated for a certain amount of time.
- Always clean the air filter at the beginning of the heating or cooling season.  
(Dust and dirt in the air filter reduce airflow, lowering the unit's capacity.)
- Clean the air filter more frequently when using the unit in a dirty environment.

## NOTES

- Do not remove the air filter for other than cleaning purposes. Doing so may cause damage to the unit.  
(The unit does not include an air filter as standard equipment.)
- Do not install any object other than a proper air filter in the suction inlet (for example, a paper towel). Doing so may result in degraded performance and cause freezing or water leakage.

### 1. Press the **FILTER SIGN RESET BUTTON** of the remote controller after the air filter is cleaned and attached.

The “” (TIME TO CLEAN AIR FILTER) display turns OFF.

Refer to the operation manual provided with the Remote controller for the positions of the “” (TIME TO CLEAN AIR FILTER) display and FILTER SIGN RESET BUTTON.

## HOW TO CLEAN AIR OUTLET AND OUTSIDE PANELS (Field supply)

1. Clean with soft cloth.
2. When it is difficult to remove stains, use water or neutral detergent.

## NOTES

- Do not use gasoline, benzene, thinner, polishing powder, liquid insecticide. It may cause discoloring or warping.
- Do not let the indoor unit get wet. It may cause an electric shock or a fire.
- Do not use hot water of 122°F or higher, as doing so may result in discoloration or deformation.

**DAIKIN AC (AMERICAS), INC.**

1645 Wallace Drive, Suite 110  
Carrollton, TX 75006

info@daikinac.com  
www.daikinac.com

**DAIKIN INDUSTRIES, LTD.**

Head office:

Umeda Center Bldg., 2-4-12, Nakazaki-Nishi,  
Kita-ku, Osaka, 530-8323 Japan

Tokyo office:

JR Shinagawa East Bldg., 2-18-1, Konan,  
Minato-ku, Tokyo, 108-0075 Japan

