

DAIKIN



OPERATION MANUAL

Wireless Remote Controller Kit

MODEL

BRC7C812

Read these instructions carefully before installation.
Keep this manual in a handy place for future reference.
This manual should be left with the equipment owner.

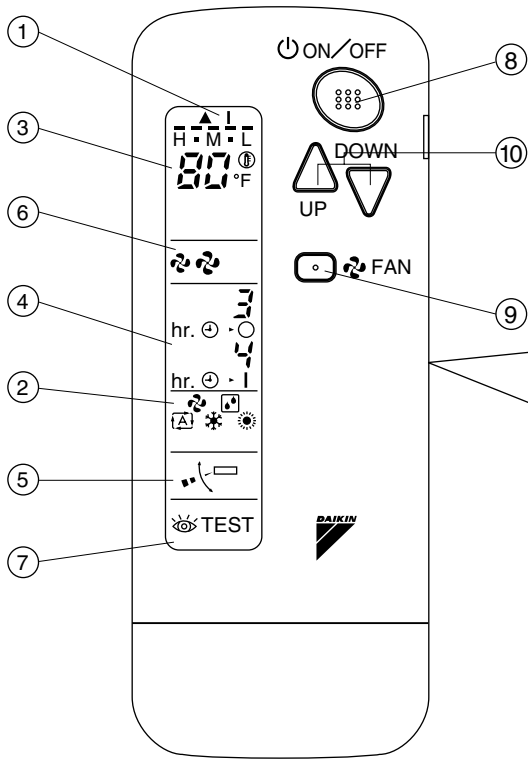

Fig. 1-1

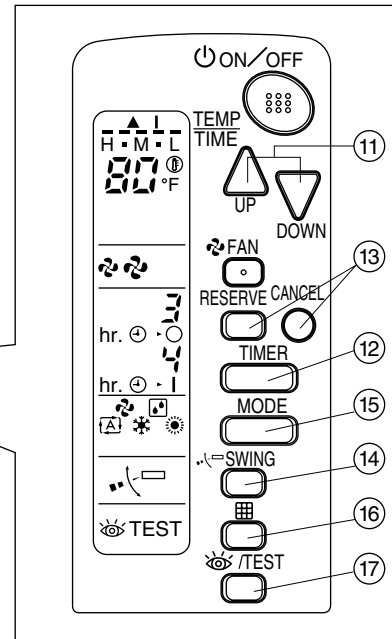

Fig. 1-2

The situation which opened the front cover of the remote control

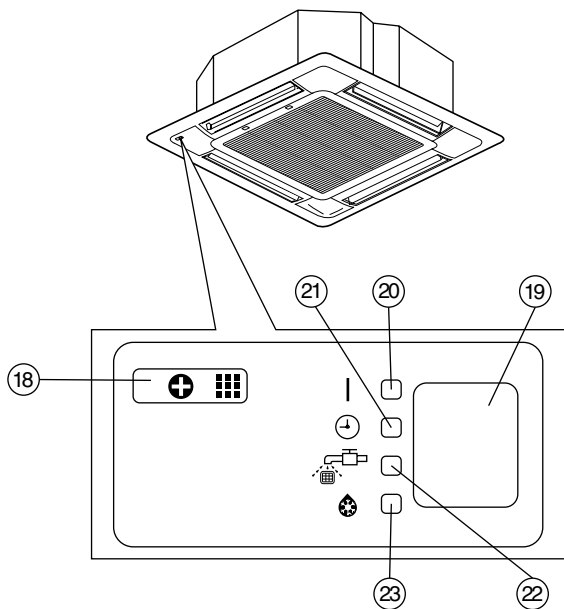

Fig. 1-3

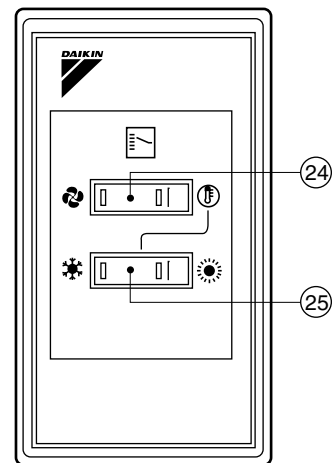

Fig. 2
COOL/HEAT CHANGEVER
REMOTE CONTROL SWITCH

CONTENTS

ILLUSTRATIONS	3
1. SAFETY CONSIDERATIONS	4
2. NAMES AND FUNCTIONS OF THE OPERATING SECTION	4
3. HANDLING FOR WIRELESS REMOTE CONTROLLER.....	5
4. OPERATION PROCEDURE	6
5. NOT MALFUNCTION OF THE AIR CONDITIONER	9
6. HOW TO DIAGNOSE TROUBLE SPOTS.....	10

1. SAFETY CONSIDERATIONS

Please read these “SAFETY CONSIDERATIONS” carefully before installing air conditioning equipment and be sure to install it correctly. After completing the installation, make sure that the unit operates properly during the start-up operation. Please instruct the customer on how to operate the unit and keep it maintained.

Also, inform customers that they should store this operation manual along with the installation manual for future reference. This air conditioner comes under the term “appliances not accessible to the general public”.

Meaning of warning, caution and note symbols.

⚠ WARNING Indication a potentially hazardous situation which, if not avoided, could result in death or serious injury.

⚠ CAUTION Indication a potentially hazardous situation which, if not avoided, may result in minor or moderate injury. It may also be used to alert against unsafe practices.

⚠ NOTE Indication situation that may result in equipment or property-damage-only accidents.

Keep these warning sheets handy so that you can refer to them if needed.

Also, if this equipment is transferred to a new user, make sure to hand over this operation manual to the new user.

⚠ WARNING













- **It is not good for your health to expose your body to the air flow for a long time.**
- **In order to avoid electric shock, fire or injury, or if you detect any abnormality such as smell of fire, turn off power and call your dealer for instructions.**
- **Ask your dealer for installation of the air conditioner.** Incomplete installation performed by yourself may result in a water leakage, electric shock, and fire.
- **Ask your dealer for improvement, repair, and maintenance.** Incomplete improvement, repair, and maintenance may result in a water leakage, electric shock, and fire.
- **Do not put a finger, a rod or other objects into the air inlet or outlet. As the fan is rotating at high speed, it will cause injury.**
- **Ask your dealer to move and reinstall the air conditioner.** Incomplete installation may result in a water leakage, electric shock, and fire.





- **Do not touch the switch with wet fingers.** Touching a switch with wet fingers can cause electric shock.
- **Do not operate the air conditioner with a wet hand.** Otherwise, you could receive an electric shock.

⚠ CAUTION

- **Do not use the air conditioner for other purposes.** In order to avoid any quality deterioration, do not use the unit for cooling precision instruments, food, plants, animals or works of art.
- **To avoid oxygen deficiency, ventilate the room sufficiently if equipment with burner is used together with the air conditioner.**
- **Do not allow a child to mount on the unit or avoid placing any object on it.** Falling or tumbling may result in injury.
- **Do not let children play on and around the unit.** If they touch the unit carelessly, it may result in injury.
- **Do not place a flower vase and anything containing water.** Water may enter the unit, causing an electric shock or fire.
- **Do not operate the air conditioner when using a room fumigation - type insecticide.** Failure to observe could cause the chemicals to become deposited in the unit, which could endanger the health of those who are hypersensitive to chemicals.
- **Never use flammable spray such as hair spray, lacquer or paint near the unit.** It may cause a fire.

2. NAMES AND FUNCTIONS OF THE OPERATING SECTION (Fig. 1-1~3, 2)

1	DISPLAY “▲” “I” (SIGNAL TRANSMISSION) This lights up when a signal is being transmitted.
2	DISPLAY “” “” “” “” “” is not installed.
3	DISPLAY “” (SET TEMPERATURE) This display shows the set temperature.
4	DISPLAY “ hr. 0.3” “ hr. 0.4” (PROGRAMMED TIME) This display shows PROGRAMMED TIME of the system start or stop.
5	DISPLAY “” (AIR FLOW FLAP) Refer to page 7.
6	DISPLAY “” “” (FAN SPEED) This display shows the set fan speed.
7	DISPLAY “ TEST” (INSPECTION/ TEST OPERATION) When the INSPECTION/TEST OPERATION BUTTON is pressed, the display shows the system mode is in.

8	ON/OFF BUTTON
	Press the button and the system will start. Press the button again and the system will stop.
9	FAN SPEED CONTROL BUTTON
	Press this button to select the fan speed, HIGH or LOW, of your choice.
10	TEMPERATURE SETTING BUTTON
	Use this button for SETTING TEMPERATURE. (Operates with the front cover of the remote controller closed.)
11	PROGRAMMING TIMER BUTTON
	Use this button for programming "START and/or STOP" time. (Operates with the front cover of the remote controller opened.)
12	TIMER MODE START/STOP BUTTON Refer to page 8.
13	TIMER RESERVE/CANCEL BUTTON Refer to page 8.
14	AIR FLOW DIRECTION ADJUST BUTTON Refer to page 7.
15	OPERATION MODE SELECTOR BUTTON Press this button to select OPERATION MODE.
16	FILTER SIGN RESET BUTTON
	Refer to the section of MAINTENANCE in the operation manual attached to the indoor unit.
17	INSPECTION/TEST OPERATION BUTTON
	This button is pressed for inspection or test operation. Do not use for normal operation.
18	EMERGENCY OPERATION SWITCH
	This switch is readily used if the remote controller does not work.
19	RECEIVER This receives the signals from the remote controller.
20	OPERATING INDICATOR LAMP (Red)
	This lamp stays lit while the air conditioner runs. It flashes when the unit is in trouble.
21	TIMER INDICATOR LAMP (Green)
	This lamp stays lit while the timer is set.
22	AIR FILTER CLEANING TIME INDICATOR LAMP (Red)
	Lights up when it is time to clean the air filter.
23	DEFROST LAMP (Orange)
	Lights up when the defrosting operation has started. (For cooling only type this lamp does not turn on.)
24	FAN/AIR CONDITIONING SELECTOR SWITCH
	Set the switch to "  " (FAN) for FAN and "  " (A/C) for HEAT or COOL.
25	COOL/HEAT CHANGEVER SWITCH
	Set the switch to "  " (COOL) for COOL and "  " (HEAT) for HEAT.

NOTE

- For the sake of explanation, all indications are shown on the display in Fig. 1-1 contrary to actual running situations.
- Fig. 1-2 shows the remote controller with the front cover opened.
- Fig. 2 shows this remote controller can be used in conjunction with the one provided with the VRV system.
- If the air filter cleaning time indicator lamp lights up, clean the air filter as explained in the operation manual provided with the indoor unit.
After cleaning and reinstalling the air filter, press the filter sign reset button on the remote controller. The air filter cleaning time indicator lamp on the receiver will go out.
- The DEFROST lamp will flash when the power is turned on. This is not a malfunction.

3. HANDLING FOR WIRELESS REMOTE CONTROLLER

- **Precautions in handling remote controller**
- **Direct the transmitting part of the remote controller to the receiving part of the air conditioner.**
If something blocks the transmitting and receiving path of the indoor unit and the remote controller as curtains, it will not operate.

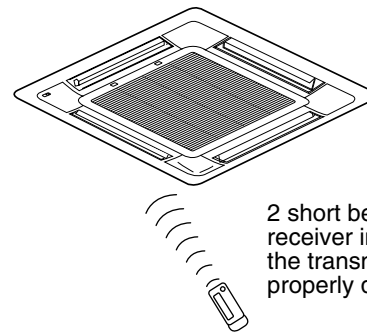

2 short beeps from the receiver indicates that the transmission is properly done.

- **Transmitting distance is approximately 23 ft..**
- **Do not drop or get it wet.**
It may be damaged.
- **Never press the button of the remote controller with a hard, pointed object.**
The remote controller may be damaged.
- **Installation site**
It is possible that signals will not be received in rooms that have electronic fluorescent lighting. Please consult with the salesman before buying new fluorescent lights.
If the remote controller operated some other electrical apparatus, move that machine away or consult your dealer.

Placing the remote controller in the remote controller holder

Install the remote controller holder to a wall or a pillar with the attached screw. (Make sure it transmits.)

Placing the remote controller

Slide from above.

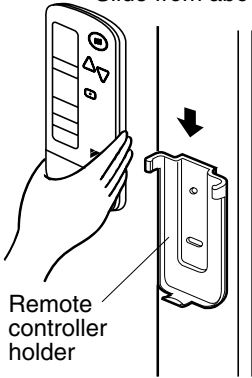

Remote controller holder

Removing the remote controller

Pull it upward.

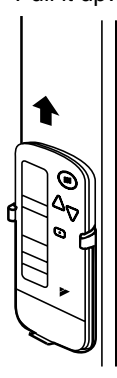

How to put the dry cell batteries

- (1) Remove the back cover of the remote controller to the direction pointed by the arrow mark.
- (2) Put the dry cell batteries. Use two LR03<AM4> dry cell batteries. Put the dry cell batteries correctly to fit their (+) and (-).
- (3) Close the back cover as before.

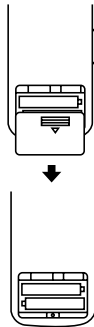

When to change batteries

Under normal use, batteries last about 1 year. However, change them whenever the indoor unit doesn't respond or responds slowly to commands, or if the display becomes dark.

CAUTION

- Replace all batteries at the same time, do not use new and old batteries intermixed.
- In case the remote controller is not used for a long time take out all batteries in order to prevent liquid leak of the battery.

IN THE CASE OF CENTRALIZED CONTROL SYSTEM

If the indoor unit is under centralized control, it is necessary to switch the remote controller's setting. In this case, contact your dealer.

4. OPERATION PROCEDURE

- Contact your dealer to confirm your system type.
- To protect the unit, turn on the main power switch 6 hours before operation.
- If the main power supply is turned off during operation, operation will restart automatically after the power turns back on again.

COOLING, HEATING, AUTOMATIC, FAN, AND PROGRAM DRY OPERATION

Operate in the following order.

- AUTOMATIC OPERATION can be selected only by Heat pump system or Heat recovery system.

《《FOR SYSTEMS WITHOUT COOL/HEAT CHANGEOVER REMOTE CONTROL SWITCH (Fig. 1-1~2 on page 3)》》

1



OPERATION MODE SELECTOR

Press **OPERATION MODE SELECTOR** button several times and select the **OPERATION MODE** of your choice as follows.

- COOLING OPERATION “❄️”
- HEATING OPERATION “☀️”
- AUTOMATIC OPERATION “🔄”
 - In this operation mode, COOL/HEAT changeover is automatically conducted.
 - For VRV system, “🔄” is not installed.
- FAN OPERATION “🌀”
- DRY OPERATION “💧”
 - The function of this program is to decrease the humidity in your room with the minimum temperature decrease.
 - The microchip automatically determines TEMPERATURE and FAN SPEED.
 - This system does not go into operation if the room temperature is below 60°F.

2



ON/OFF

Press **ON/OFF** button.

OPERATING INDICATOR lamp lights up or goes off and the system starts or stops OPERATION.



NOTE

- Do not turn off power immediately after the unit stops. Then, wait no less than 5 minutes. Water is leaking or there is something else wrong with the unit.

《《FOR SYSTEMS WITH COOL/HEAT CHANGEOVER REMOTE CONTROL SWITCH (Fig. 2 on page 3)》》

1



OPERATION MODE SELECTOR

(1) Select **OPERATION MODE** with the **COOL/HEAT CHANGEOVER REMOTE CONTROL SWITCH** as follows.

- COOLING OPERATION “❄️”
- HEATING OPERATION “☀️”
- FAN OPERATION “🌀”
- DRY OPERATION “💧”

- See “FOR SYSTEM WITHOUT COOL/HEAT CHANGEOVER REMOTE CONTROL SWITCH” for details on dry operation.

(2) Press OPERATION MODE SELECTOR button several times and select “ ”.
(This operation is only available during dry operation.)



Press ON/OFF button.

OPERATING INDICATOR lamp lights up or goes off and the system starts or stops OPERATION.

NOTE

- Do not turn off power immediately after the unit stops. Then, wait no less than 5 minutes.
Water is leaking or there is something else wrong with the unit.

[EXPLANATION OF HEATING OPERATION]

DEFROST OPERATION

- As the frost on the coil of an outdoor unit increase, heating effect decreases and the system goes into DEFROST OPERATION.
- The fan operation stops and the DEFROST lamp of the indoor unit goes on.
- After 6 to 8 minutes (maximum 10 minutes) of DEFROST OPERATION, the system returns to HEATING OPERATION.

Heating capacity & Outdoor air temperature

- Heating capacity drops as outdoor air temperature lowers. If feeling cold, use another heater at the same time as this air conditioner.
- Hot air is circulated to warm the room. It will take some time from when the air conditioner is first started until the entire room becomes warm. The internal fan automatically turns at low speed until the air conditioner reaches a certain temperature on the inside. In this situation, all you can do is wait.
- If hot air accumulates on the ceiling and feet are left feeling cold, it is recommended to use a circulator. For details, contact the place of purchase.

ADJUSTMENT

For programming TEMPERATURE, FAN SPEED and AIR FLOW DIRECTION, follow the procedure shown below.



TEMPERATURE SETTING

Press TEMPERATURE SETTING button and program the setting temperature.

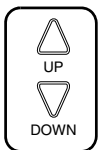

Each time this button is pressed, setting temperature rises 1°F.

Each time this button is pressed, setting temperature lowers 1°F.

In case of automatic operation

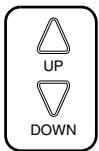

Each time this button is pressed, setting temperature shifts to “H” side.

Each time this button is pressed, setting temperature shifts to “L” side.

[°F]

	H	•	M	•	L
Setting temperature	77	73	71	70	66

- The setting is impossible for fan operation.

NOTE

- The setting temperature range of the remote controller is 60°F to 90°F.



FAN SPEED CONTROL

Press FAN SPEED CONTROL button.

High or Low fan speed can be selected.

The microchip may sometimes control the fan speed in order to protect the unit.



AIR FLOW DIRECTION ADJUST

Press the AIR FLOW DIRECTION ADJUST button to adjust the air flow angle.

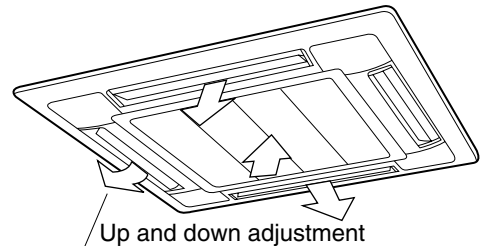

- The movable limit of the blade is changeable. Contact your dealer for details.

Press the AIR FLOW DIRECTION ADJUST button to select the air direction as shown below.

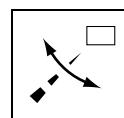

DISPLAY appears and the air flow direction continuously varies. (Automatic swing setting)



Press AIR FLOW DIRECTION ADJUST button to select the air direction of your choice.



DISPLAY vanishes and the air flow direction is fixed. (Fixed air flow direction setting)

MOVEMENT OF THE AIR FLOW FLAP

For the following conditions, the microchip controls the air flow direction so it may be different from the display.

Operation mode	Cooling	Heating
Operation condition	<ul style="list-style-type: none"> When operating continuously at horizontal at horizontal air flow direction. 	<ul style="list-style-type: none"> When room temperature is higher than the set temperature At defrost operation (Air flow direction becomes horizontal so that cool air is not exposed directly to the human body)

NOTE

- If you try cooling or programmed drying, while the flaps are facing downward, air flow direction may change unexpectedly. There is nothing wrong with the equipment. This serves to prevent dew formed on parts in the air discharge outlet from dripping.
- Operation mode includes automatic operation.

PROGRAM TIMER OPERATION

Operate in the following order.

- The timer is operated in the following 2 ways.
Programming the stop time (⊕ · ○)
.... The system stops operating after the set time has elapsed.
Programming the start time (⊕ · |)
.... The system starts operating after the set time has elapsed.
- The timer can be programmed a maximum of 72 hours.
- The start and the stop time can be simultaneously programmed.



1 TIMER MODE START/STOP

Press the **TIMER MODE START/STOP** button several times and select the mode on the display.

The display flashes.

For setting the timer stop "⊕ · ○"

For setting the timer start "⊕ · |"



2 PROGRAMMING TIMER

Press the **PROGRAMMING TIMER** button and set the time for stopping or starting the system.

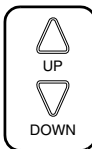

When this button is pressed, the time advances by 1 hour.

When this button is pressed, the time goes backward by 1 hour.



3 TIMER RESERVE

Press the **TIMER RESERVE** button.

The timer setting procedure ends.

The display changes from flashing light to a constant light.



4 TIMER CANCEL

Press the **TIMER CANCEL** button to cancel programming. The display vanishes.

For example.

When the timer is programmed to stop the system after 3 hours and start the system after 4 hours, the system will stop after 3 hours and then 1 hour later the system will start.

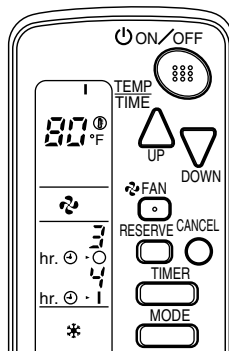

NOTE

- After the timer is programmed, the display shows the remaining time.

HOW TO SET MASTER REMOTE CONTROLLER (For VRV system)

- When the system is installed as shown below, it is necessary to designate the master remote controller.

■ For Heat pump system

When 1 outdoor unit is connected with several indoor units.

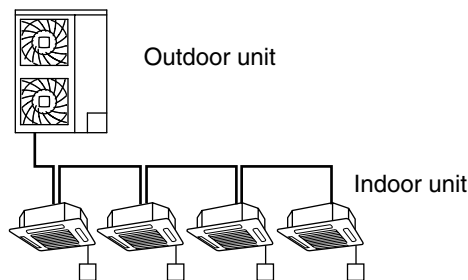

One of these remote controllers needs to be designated as the master remote controller.

■ For Heat recovery system

When 1 BS unit is connected with several indoor units.

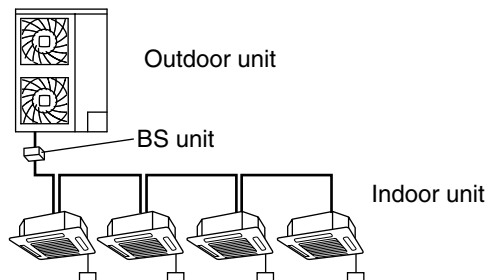

One of these remote controllers needs to be designated as the master remote controller.

- Only the master remote controller can select HEATING, COOLING or AUTOMATIC OPERATION.

When the indoor unit with master remote controller is set to "COOL", you can switch over operation mode between "FAN", "DRY" and "COOL".

When the indoor unit with master remote controller is set to "HEAT", you can switch over operation mode between "FAN" and "HEAT".

When the indoor unit with master remote controller is set to "FAN", you cannot switch operation mode.

1 long beep When attempting settings than that consented above.
Only with Heat recovery system, you can set the indoor unit to AUTOMATIC.
Attempting to do so.

How to designate the master remote controller

Operate in the following order.



Continuously press the OPERATION MODE SELECTOR button for 4 seconds.

The displays showing "⊕" of all slave indoor unit connected to the same outdoor unit or BS unit flash.



Press the OPERATION MODE SELECTOR button to the indoor unit that you wish to designate as the master remote controller. Then designation is completed. This indoor unit is designated as the master remote controller and the display showing "⊕" vanishes.

- To change settings, repeat steps ① and ②.

EMERGENCY OPERATION

When the remote controller does not work due to battery failure or the absence there of, use this switch which is located beside the discharge grille on the indoor unit. When the remote controller does not work, but the battery low indicator on it is not lit, contact your dealer.

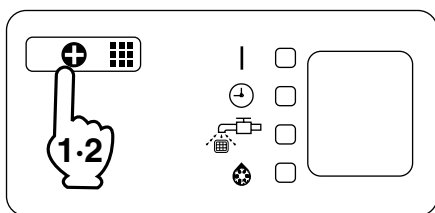

[START]

- 1 Press the EMERGENCY OPERATION switch.

The machine runs in the previous mode.
The system operates with the previously set air flow direction.

[STOP]

- 2 Press the EMERGENCY OPERATION switch again.

PRECAUTIONS FOR GROUP CONTROL SYSTEM OR 2 REMOTE CONTROLLERS CONTROL SYSTEM

This system provides 2 other control systems beside individual control (1 remote controller controls 1 indoor unit) system. Confirm the following if your unit is of the following control system type.

■ Group control system

1 remote controller controls up to 16 indoor units.
All indoor units are equally set.

■ 2 remote controllers control system

2 remote controllers control 1 indoor unit.
(In case of group control system, 1 group of indoor units)
The unit follows individual operation.

⚠ NOTE

- Cannot have 2 remote controllers control system with only wireless remote controllers. (It will be a 2 remote controllers control system having 1 wired and 1 wireless remote controllers.)
- Under 2 remote controllers control system, wireless remote controller cannot control timer operation.
- Only the operating indicator lamp out of 3 other lamps on the indoor unit display functions.
- Contact your dealer in case of changing the combination or setting of group control and 2 remote controllers control systems.

5. NOT MALFUNCTION OF THE AIR CONDITIONER

The following symptoms do not indicate air conditioner malfunction.

■ THE SYSTEM DOES NOT OPERATE

- **The system does not restart immediately after the ON/OFF button is pressed.**
If the OPERATING INDICATOR lamp lights, the system is in normal condition. It does not restart immediately because a safety device operates to prevent overload of the system. After 3 minutes, the system will turn on again automatically.
- **The system does not restart immediately when TEMPERATURE SETTING button is returned to the former position after pushing the button.**
It does not restart immediately because a safety device operates to prevent overload of the system. After 3 minutes, the system will turn on again automatically.
- **If the reception beep is rapidly repeated 3 times. (It sounds only 2 times when operating normally.)**
Control is set to the optional controller for centralized control.

- **If the DEFROST lamp on the indoor unit's display is lit when heating is started.**
This indication is to warn against cold air being blown from the unit. There is nothing wrong with the equipment.

■ The unit stops operation from time to time.

- **With "U4" "U5" displayed on the remote controller, the unit stops, but it resumes operation in a few minutes.**
Since electric noises produced from other equipment than the air conditioner interrupt communication between the units, the unit stops operation.
If these electric noises subside, operation is restarted automatically.

■ **COOLING / HEATING changeover is impossible.**

- If the indoor unit emits a receiving sound “1 long beep”. It is because the indoor unit under the control of operation changeover is set to the mode that cannot be selected.

■ **Display Indicates only a part.**

- Even if the unit is in operation, the display shows only operational indication. Even if the indication is shown, the indication other than operation disappears after a while. It is because the remote controller is set to multi-system.

■ **Display disappears or shows all indication.**

- It happens when the button of the remote controller is pressed. It is because the battery is dead.

■ **No favorable cooling is achieved.**

- The unit is in **DRY OPERATION**. DRY OPERATION is carried out to perform operation such that the room temperature is not decreased as much as possible.

6. HOW TO DIAGNOSE TROUBLE SPOTS

■ **EMERGENCY STOP**

When the air conditioner stops in emergency, the run lamp on the indoor unit starts blinking. Take the following steps yourself to read the malfunction code that appears on the display. Contact your dealer with this code. It will help pinpoint the cause of the trouble, speeding up the repair.

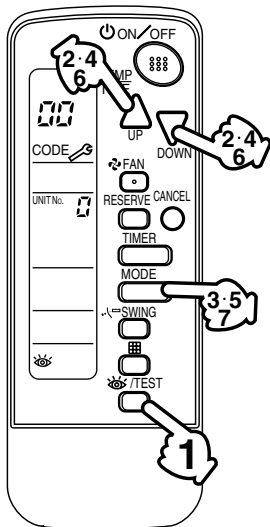

Press the INSPECTION/TEST OPERATION button to select the inspection mode “”.

“” appears on display and blinks. “UNIT No.” lights up.



Press PROGRAMMING TIMER button and change the unit number.

Press to change the unit number until the indoor unit beeps and perform the following operation according to the number of beeps.

Number of beeps

- 3 short beeps Perform all steps from **3** to **6**.
- 1 short beep Perform **3** and **6** steps.
- 1 long beep Normal state



Press OPERATION MODE SELECTOR button.

“” on the left-hand of the malfunction code blinks.



Press PROGRAMMING TIMER button and change the malfunction code.

Press until the indoor unit 2 beeps.



Press OPERATION MODE SELECTOR button.

“” on the right-hand of the malfunction code blinks.



Press PROGRAMMING TIMER button and change the malfunction code.

Press until the indoor unit makes 1 long beep.

The malfunction code is fixed when the indoor unit makes 1 long beep.



Reset of the display

Press OPERATION MODE SELECTOR button to get the display back to the normal state.

■ **IN CASE BESIDES EMERGENCY STOP**

- The unit does not operate at all.
 - Check if the receiver is exposed of sunlight or strong light. Keep receiver away from light.
 - Check if there are batteries in the remote controller. Place the batteries.
 - Check if the indoor unit number and wireless remote controller number are equal.

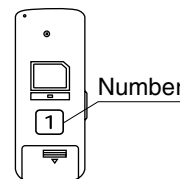
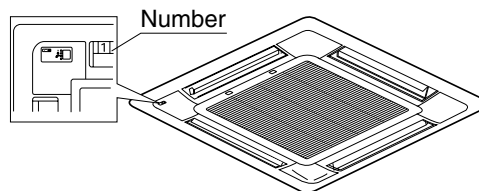

Operate the indoor unit with the remote controller of the same number.

Signal transmitted from 1 remote controller of a different number cannot be accepted. (If the number is not mentioned, it is considered as "1".)

■ **The system operates but it does not sufficiently cool or heat.**

- If the set temperature is not proper. (See page 7)
- If the FAN SPEED is set to LOW SPEED. (See page 7)
- If the air flow angle is not proper. (See page 7)

Contact the place of purchase in the following case.



WARNING

When you detect a burning odor, shut OFF power immediately and contact the place of purchase. Using the equipment in anything but proper working condition can result in equipment damage, electric shock or fire.

[Trouble]

■ **The OPERATING INDICATOR lamp of the indoor unit is flashing and the unit does not work at all.**

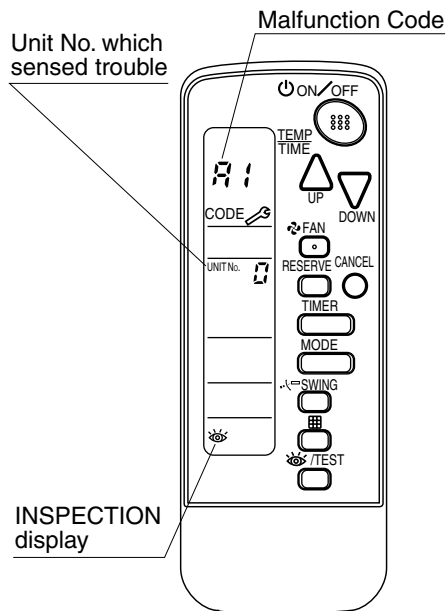

Check the malfunction code (A1 - UF) on the remote controller and contact the place of purchase. (Refer to indoor unit installation manual.)

DAIKIN U.S. CORPORATION

375 Park Avenue, Suite 3308
New York, N.Y. 10152

info@daikinac.com

www.daikinac.com