

16.1.4 Installation Manual

1 COMPONENTS

Check the following components are included in this optional accessory before installation.

Installation screw (M4 x 16)	4
Operation manual	1
Installation manual	1
Installation table	1

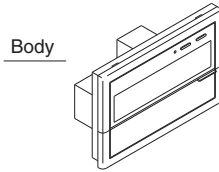

When using this optional accessory an electric parts box of KJB311A is required. For installation, a steel electric parts box to be embedded is necessary.

2 SYSTEM CONFIGURATION

With the central remote controller, unified ON/OFF is possible with up to a maximum 64 groups of indoor units.
 When using 2 central remote controllers, unified operation is possible with up to a maximum 128 groups.
 With this optional accessory, setting of control modes including operation, stop, operation controlled by timer, and ON/OFF control possible/impossible by remote controller can be set individually by zones while it enables to control and display the operation state such as set temperature.
 It can be connected with the external key system, BMS, etc., through forced OFF input (no-voltage normally open contactor).
 A zone is a one or more groups together. In general, the same settings are used throughout a zone.

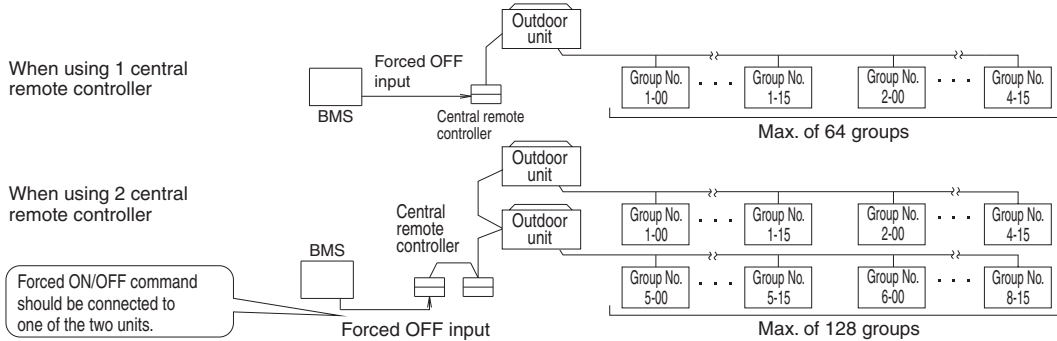

The central remote controller and the separately sold remote control adaptor circuit board or group remote control adaptor cannot be used together. See the D-BACS design guide for details.

3 INSTALLATION

- (1) Open the upper part of remote controller.
 Insert a ⊖ screwdriver (2 locations) into the recess between the upper part and the lower part of remote controller and twist the screwdriver lightly.

PC board is attached with both the upper and lower part of remote controller. Do not damage the board with the screwdriver.

- (2) Open the upper part of remote controller and install the Electric parts box with the attached installation screws (M4 x 16).

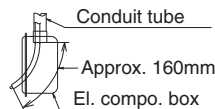

NOTE) Suitable length of the electric wire is about 160mm. (from el. compo. box)
 If it is difficult to contain a long wiring, strip the sheathed part of the wiring.

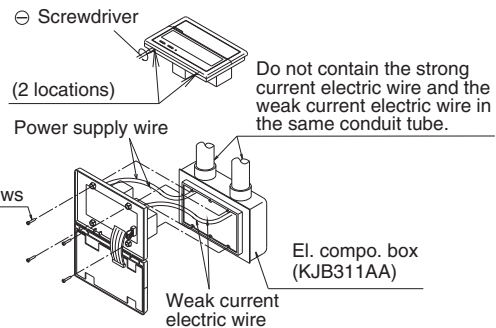

C: 2P162816

4 INITIAL SETTING

Setting (1) through (3) are initialized when power is turned ON, therefore complete settings BEFORE activating the power. (The positions of connectors and switches used for settings in this section are shown in Fig. 1.)

- (1) Connector for setting master controller (X1A) (Provided with connector at factory set)
- When using only 1 central remote controller, do not disconnect the connector for setting master controller. (Use the unit with the connector in the state in which it was delivered.)
 - When using multiple central remote controllers, or using the central remote controller in conjunction with the optional controllers for centralized control, makes settings as indicated in the below table.

Pattern of connection of optional controllers for centralized control			Connector for setting master controller (X1A) Setting, Removed		
Central remote controller	Unified ON/OFF controller	Schedule timer	Central remote controller	Unified ON/OFF controller	Schedule timer
1 to 4	1 to 16	1	Set one to "Used" and all the rest to "Not used"	Set all to "Not used"	"Not used"
		1			"Not used"

(Remove all the connectors for the central remote controller, the on/off controller, and the schedule timer when using the unit together with the Ve-UP controller, the master station II, the DMS interface, the payment management unit, or the parallel interface station.)

- (2) Address setting
Two central remote controllers can be used as shown in **2 SYSTEM CONFIGURATION**, to control anywhere up to a max. 128 groups of indoor units. In this case, group address must be set. This is done with the switch for setting each address (SS3).

SS3 setting	Indoor unit address	SS3 setting	Indoor unit address
SETTING EACH ADDRESS 5-00 ~ 8-15	To control indoor units from group Nos. 1-00 through 4-15	SETTING EACH ADDRESS 5-00 ~ 8-15	To control indoor units from group Nos. 5-00 through 8-15

- (3) MAIN/SUB changeover switch setting
With two central remote controllers, centralized control (indoor units) is possible from different locations. In this kind of set-up, it is necessary to set the MAIN/SUB changeover switch.

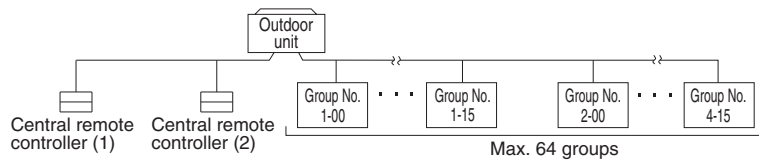

One of the two central remote controllers (1) - (2) is set to "MAIN" while the other is set to "SUB".

- (4) Setting of the sequential operation function
The central remote controller is equipped with a sequential operation function that sequentially turns indoor units on in 2-second intervals during unified operation. (Sequential operation is factory set to "ON.") To switch sequential operation ON or OFF, set as follows.

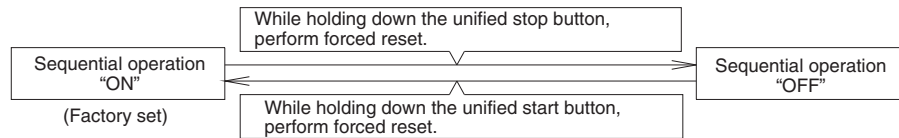

NOTE: The sequential operation function is designed to reduce the load on the power supply equipment, but does not guarantee that compressors will not be started simultaneously. You cannot therefore count on a capacity reduction effect by power supply equipment breaker selection.

- (5) Forced reset switch
When changing the setting of the connector for setting master controller, etc., you can reset simply by setting it to the reset side once and returning to the normal side, without turning the power OFF. (For normal operation, set the switch to the normal side.)

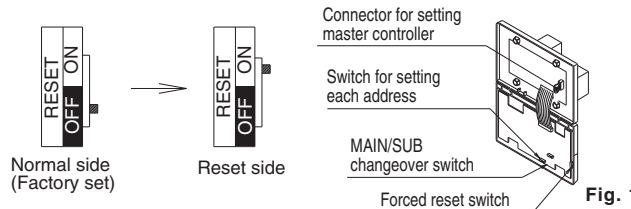
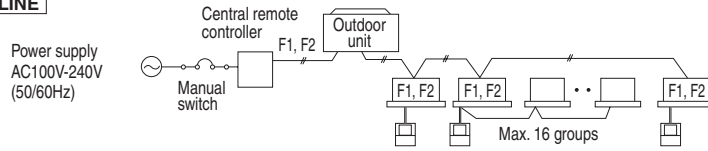

Fig. 1

5 ELECTRIC WIRING

WIRING OUTLINE



WIRING TO THE INDOOR UNIT AND OUTDOOR UNIT

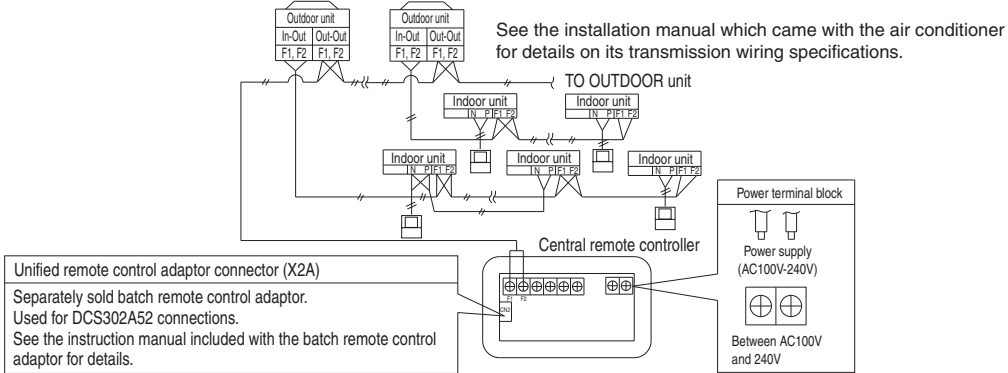

Wiring specifications

Power supply wiring	2mm ²
Transmission wiring for control	0.75 – 1.25 mm ² sheathed vinyl cord or cable (balanced type) – maximum length 1000 m (total overall wiring length 2000 m)
Manual switch	10A or 15A

Wire the indoor units to the outdoor units and between all power, indoor units, and remote controllers. See the installation manual included with the indoor and outdoor units for details.

CONTROL TERMINAL STRIP

- *1 For connecting Indoor unit (F1, F2)
- *2 Forced OFF input (T1, T2)
None of the indoor units connected to the forced OFF input contact (non-voltage contact with minimal current) will operate when it is shut off.
Use only contactors which guarantee the minimum applicable load DC 16V, 10mA.
T1 — DC16V NOTE) Use instantaneous contactor of over 200m sec. energizing time, when necessary.
T2 —
- *3 For schedule timer (D1, D2)
Power can be supplied to the schedule timer (DST301B51·61) separately sold. For details, refer to the installation manual of the schedule timer.
Wire *2 and *3 only when necessary.

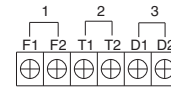





(NOTE)

Do not connect the power supply wiring (100 to 240V) to the control terminal strip. If connected by mistake, it may damage or burn electrical parts of optional controllers for centralized control and indoor unit. It may result in serious danger. Be sure to check wirings before turning the power ON.

2P162816

6 SETTING GROUP NO. FOR CENTRALIZED CONTROL

Set the group number of each group of the indoor unit from the remote controller. (In case of no remote controller, also connect the remote controller and set the group No. Then, remove the remote controller.)

- (1) Turn ON the power of the indoor unit and central remote controller.
(Unless the power is ON, no setting can be made.)
Check that the installation and electrical wiring are correct before turning the power supply ON.
(When the power supply is turned ON, all LCD appear once and the unit may not accept the operation for about one minute with the display of “88”.)
- (2) While in the normal mode, hold down the “” button for a minimum of 4 seconds.
The remote controller will enter the FIELD SET MODE.
- (3) Select the MODE No. “88” with the “” button.
- (4) Use the “” button to select the group No. for each group.
(Group numbers increase in the order of 1-00,1-01,...1-15, 2-00, ...8-15.)
- (5) Press “” to set the selected group No.
- (6) Press “” to return to the NORMAL MODE.

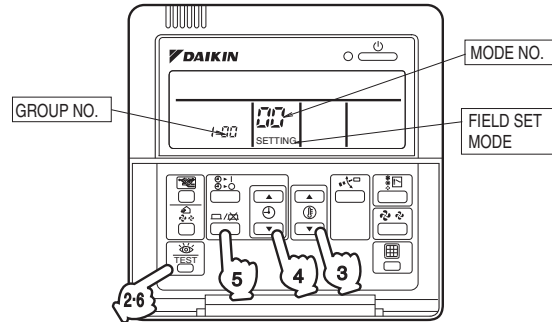









- NOTES)
- For simplified remote controller, see the installation table.
 - See the installation manuals which came with the Ventiair and adaptors (i.e., multi-purpose adaptors) for details on their Group No. settings.

NOTICE Enter the group No. and installation place of the indoor unit into the installation table in the operation manual. Be sure to keep the operation manual for maintenance.

7 TEST OPERATION (Perform a test operation in the individual screen before registering zones.)

Before starting test operation, check that the power is supplied to the indoor and outdoor units, and central remote controller.

- (1) Select the display “INDIVIDUALLY”
Press “” button to display “INDIVIDUALLY”
- (2) Select the group to be tested.
Select the group No. with “” “” “” “” button.
- (3) Press “” button to select the test operation mode.
“TEST” is displayed.
“HOST A” is displayed on the remote controller.
- (4) Press “” button within 10 seconds after entering into the test operation mode.
Operation the unit for 30 minutes.
When pressing the “” button, the unit stops operating.
If the operation lamp flashes, it indicates a malfunction.
Call the group of flashing display, confirm malfunction code, and check the source of malfunction.
(The operation manual lists all error codes, so refer to it.)

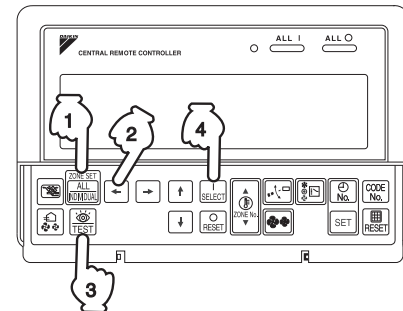

- NOTES)
- For test operation, refer to the installation manual of the outdoor unit.
 - After turning the power supply ON, if the unit does not accept operation for two minutes or more with the display of “88”, check the following points.
 - Check that setting of the connector for setting master controller is correct.
 - Check that the group No. for centralized control has been set.

2P162816