

**DAIKIN**



# INSTALLATION MANUAL

---

## Wireless Remote Controller Kit

---

MODELS

**BRC7C812**

Read these instructions carefully before installation.  
Keep this manual in a handy place for future reference.  
This manual should be left with the equipment owner.

## CONTENTS

1. SAFETY CONSIDERATIONS.....	2
2. BEFORE INSTALLATION .....	2
3. REMOTE CONTROLLER INSTALLATION .....	2
4. RECEIVER INSTALLATION.....	3
5. FIELD SETTING.....	4
6. TEST OPERATION.....	5

## 1. SAFETY CONSIDERATIONS

Please read these "SAFETY CONSIDERATIONS" carefully before installing air conditioning equipment and be sure to install it correctly. After completing the installation, make sure that the unit operates properly during the start-up operation. Please instruct the customer on how to operate the unit and keep it maintained.

Also, inform customers that they should store this installation manual along with the operation manual for future reference. This air conditioner comes under the term "appliances not accessible to the general public".

Meaning of warning, caution and note symbols.

**⚠ WARNING** ..... Indication a potentially hazardous situation which, if not avoided, could result in death or serious injury.

**⚠ CAUTION** ..... Indication a potentially hazardous situation which, if not avoided, may result in minor or moderate injury. It may also be sued to alert against unsafe practices.

**⚠ NOTE** ..... Indication situation that may result in equipment or property-damage-only accidents.

### ⚠ WARNING

• **Perform installation work in accordance with this installation manual.**

Improper installation may result in electric shocks or fire.

• **Be sure to use only the specified accessories and parts for installation work.**

Failure to use the specified parts may result in, electric shocks, fire or the unit falling.

• **Before touching electrical parts, turn off the unit.**

• **Do not touch the switch with wet fingers.**

Touching a switch with wet fingers can cause electric shock.

### ⚠ CAUTION

• **Refer also to the installation manuals attached to the indoor unit and the decoration panel.**

• **Confirm that the following conditions are satisfied prior to installation.**

Ensure that nothing interrupts the operation of the wireless remote controller. (Ensure that there is neither a source of light nor fluorescent lamp near the receiver. Also, ensure that the receiver is not exposed of direct sunlight.)

Ensure that the operation display lamp and other indicators are easy to see.



• **The installation position of this receiver is one corner of the decoration panel. Therefore, confirm that its position is set so that the signal from the wireless remote controller can be easily transmitted and its display can be easily seen.**



• **If both this kit and fresh air intake kit are installed, only one duct chamber shall be used. Refer to the installation manual of the fresh air intake kit (optional hand book).**

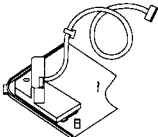

## 2. BEFORE INSTALLATION

### 2-1 ACCESSORIES

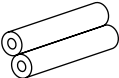
Check if the following accessories are included with the unit.

Name	(1) Receiver	(2) Wireless remote controller	(3) Remote controller holder
Quantity	1 set	1 pc.	1 pc.
Shape			

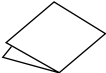
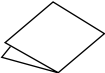
Name	(4) Dry cell battery LR03 (AM4)	(5) Unit No. label	(6) Screw for installing remote controller holder
Quantity	2 pcs.	1 pc.	2 pcs.
Shape			

Name	(7) Operation manual	(8) Installation manual	(9) Sealing pad
Quantity	1 pc.	1 pc.	1 pc.
Shape			

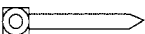
Name	(10) Clamp
Quantity	1 pc.
Shape	

### 2-2 NOTE TO THE INSTALLER

Be sure to instruct the customer how to properly operate the system showing him/her the attached operation manual.

## 3. REMOTE CONTROLLER INSTALLATION

### <Installing wireless remote controller>

• Do not throw the remote controller or impose large shocks. Also, do not store where it may be exposed to moisture or direct sunlight.

• When operating, point the transmitting part of the remote controller in the direction of the receiver.

- The direct transmitting distance of the remote controller is approximately 23 ft.
- The signal cannot be transmitted if something such as curtains blocks the receiver and the remote controller.

**Installing to a wall or a pillar**

1. Fix the remote controller holder (3) with the screws (6).

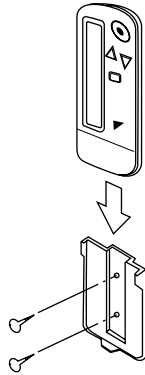

2. Slide the remote controller (2) into the remote controller holder (3) from the top.

**How to put the dry batteries**

1. Remove the back cover of the remote controller (2) to the direction pointed by the arrow mark.
2. Put the dry cell batteries. Use two LR03<AM4> dry cell batteries (4). Put the dry cell batteries (4) correctly to fit their (+) and (-).
3. Close the back cover as before.

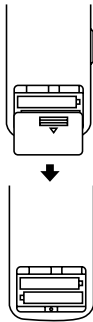

**4. RECEIVER INSTALLATION**

**4-1. Preparations before installation**

Remove the control box lid and the front grill. See the installation manual that came with the indoor unit for details on removal.

**4-2. Determination of address and MAIN/SUB remote controller**

If setting multiple wireless remote controllers to operate in 1 room, perform address setting for the receiver and the wireless remote controller. If setting multiple wired remote controllers in 1 room, change the MAIN/SUB switch of the receiver.

**4-3. Setting procedure**

- Setting the receiver  
Set the wireless address switch (SS2) on the transmission PC-board (2) according to the table below.

Unit No.	No.1	No.2	No.3
Wireless address switch (SS2)			

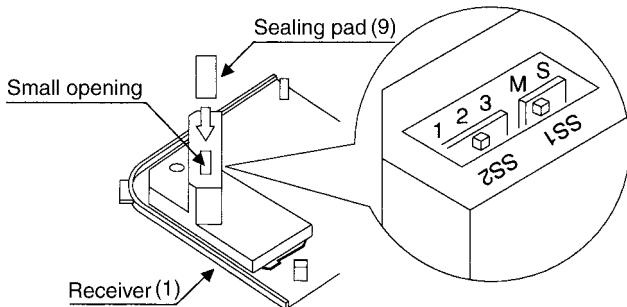

**CAUTION**

Change the setting so that the internal electronic equipments are not damaged with a pen etc.

When using both a wired and a wireless remote controller for 1 indoor unit, the wired controller should be set to MAIN. Therefore, set the MAIN/SUB switch (SS1) of the receiver to SUB.

	MAIN	SUB
MAIN/SUB switch (SS1)		

After completing setting, seal off the opening of the address switch and the MAIN/SUB switch with the attached sealing pad.

**4-4. Receiver installation**

**CAUTION**

Be sure to turn off the power before operation.

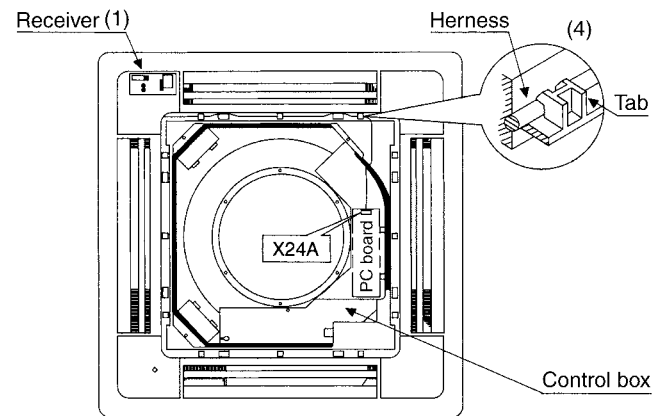
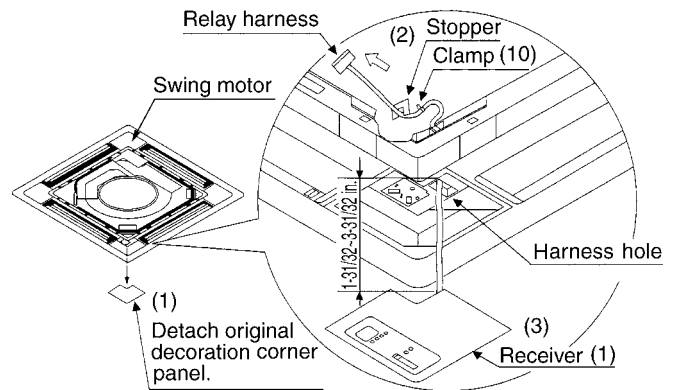

- (1) Detach the swing motor and the diagonally opposite decoration corner panel. This corner panel piece is not needed here after. (Refer to (1) in drawing)

<For instructions on attaching / detaching decoration panels, see the installation instructions provided with the original panel.>

**The receiver (1) cannot be installed anywhere but in this corner.**

- (2) Pull the relay harness from the receiver (1) up to where the clamp (10) meets the stopper, as shown above. (Refer to (2) in drawing)
- (3) Install the receiver (1) where the decoration corner panel was. Proceed in the opposite order in which you removed the corner panel. (Refer to (3) in drawing)
- (4) Fit the relay harness under the tab on the decoration panel and connect it to connector X24A on the indoor unit PC board. Bundle the remaining harness with the included clamp so that it does not droop or get pinched in the suction grille. (Refer to (4) in drawing)
- (5) Attach the lid to the indoor unit's control box and the suction grille to the decoration panel. (Refer to installation manual of indoor unit.)

#### 4-5. Setting the address of wireless remote controller (It is factory set to "1".)

<Setting from the remote controller>

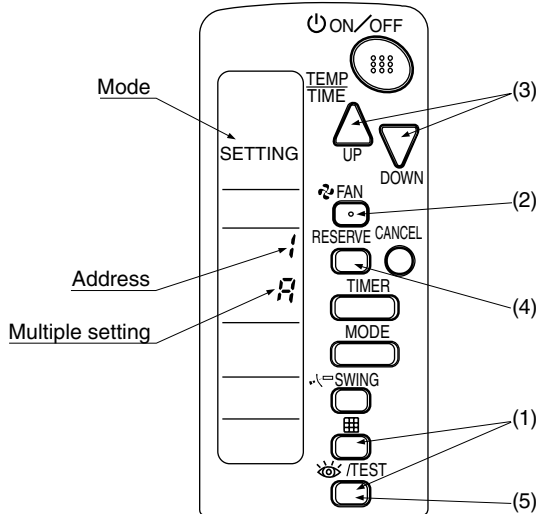

- (1) Hold down the " [Grid] " button and the " [TEST] " button for at least 4 seconds to get the FIELD SET MODE. (Indicated in the display area in the figure at top.)
- (2) Press the " [FAN] " button and select a multiple setting (A/b). Each time the button is pressed the display switches between "A" and "b".
- (3) Press the " [UP] " button and " [DOWN] " button to set the address.

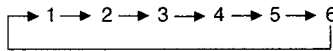

Address can be set from 1 to 6, but set it from 1 to 3 and to same address as the receiver. (The receiver does not work with address from 4 to 6.)

- (4) Press the " [RESERVE] " button to enter the setting.
- (5) Push the " [TEST] " button to quit the FIELD SET MODE and return to the normal display.

<Multiple settings A/b>

When the indoor unit is being operating by outside control (central remote controller, etc.), it sometimes does not respond to ON/OFF and temperature setting commands from this remote controller. Check what setting the customer wants and make the multiple setting as shown below.

Remote controller		Indoor unit	
Multiple setting	Remote controller display	To control other air conditions and units	For other than on left
A: Standard	All items displayed.	Commands other than ON/OFF and temperature setting accepted. (1 LONG BEEP or 3 SHORT BEEPS emitted)	
b: Multi System	Operations remain displayed shortly after execution	All commands accepted. (2 SHORT BEEPS)	

#### 4-6. Stick the Unit No. label on the air outlet of the decoration panel and the back of the wireless remote controller.

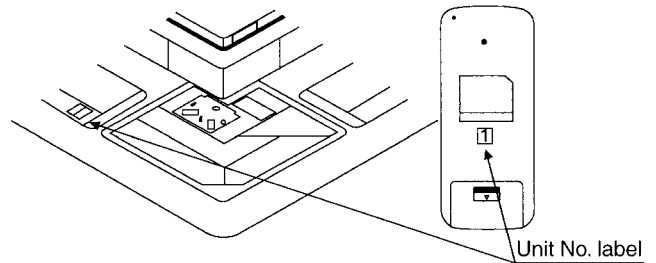

#### CAUTION

Set the Unit No. of the receiver and the wireless remote controller to be equal. If the settings differ, the signal from the remote controller cannot be transmitted.

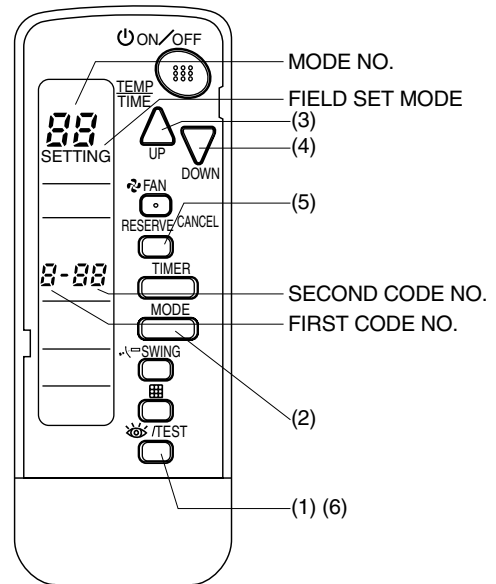

### 5. FIELD SETTING

If optional accessories are mounted on the indoor unit, the indoor unit setting may have to be changed. Refer to the instruction manual (optional hand book ) for each optional accessory.



#### Procedure

- (1) When in the normal mode, press the " [TEST] " button for at least 4 seconds, and the FIELD SET MODE is entered.

- (2) Select the desired MODE NO. with the “ **MODE** ” button.
- (3) Push the “  ” button and select the FIRST CODE NO..
- (4) Push the “  ” button and select the SECOND CODE NO..
- (5) Push the “ **RESERVE** ” button and the present settings are set.
- (6) Push the “  ” button to quit the FIELD SET MODE and return to the normal display.

(Example) If the time to clean air filter is set to “Filter Contamination-Heavy”, set Mode No. to “10”, FIRST CODE NO. to “0”, and SECOND CODE NO. to “02”.

MODE NO.	FIRST CODE NO.	DESCRIPTION OF SETTING	
10	0	Filter Contamination-Heavy/Light (Setting for spacing time of display time to clean air filter) (Setting for when filter contamination is heavy, and spacing time of display time to clean air filter is to be halved)	Long-life type
			Standard type
	1	Long-life filter type (Setting of filter sign indication time)	
	3	Spacing time of display time to clean air filter count (Setting for when the filter sign is not to be displayed)	
12 (VRV system)	1	ON/OFF input from outside (Set to enable starting/stopping from remote.)	
	2	Thermostat differential changeover (Set when using remote controller thermostat sensor.)	
13	4	Air Flow Direction Range Setting	

MODE NO.	FIRST CODE NO.	SECOND CODE NO. NOTE)				
		01	02	03		
10	0	Light	Approx. 2,500 hours	Heavy	Approx. 1,250 hours	—
			Approx. 200 hours		Approx. 100 hours	
	1	Long-life filter		—	—	
	3	Display	Do not display		—	
12 (VRV system)	1	Forced OFF input	ON/OFF		—	
	2	2°F	1°F		—	
13	4	Upper	Normal	Lower		

**NOTE**

The SECOND CODE NO. is factory set to “01”. However, for the following cases it is set to “02”.

- Air Flow Direction Range Setting

Do not use any settings not listed in the table.



For group control with a wireless remote controller, initial settings for all the indoor units of the group are equal. (For group control, refer to the installation manual attached to the indoor unit for group control.)

## 6. TEST OPERATION

- Perform test operation according to the instructions in the installation manual attached to the indoor unit.
- After refrigerant piping, drain piping, and electric wiring, operate according to the table to protect the unit.

**CAUTION**

1. Refer to a malfunction code in the installation manual attached to the outdoor unit if it does not operate.
2. Refer to the installation manual attached to the outdoor unit for individual operation system types.

Order	Operation
(1)	Open gas side stop valve.
(2)	Open liquid side stop valve.
(3)	Electrify crank case heater for 6 hours.
(4)	Set to cooling with the remote controller and push “ <b>ON/OFF</b> ” button to start operation.
(5)	Push “  ” button twice and operate in TEST OPERATION MODE for 3 minutes.
(6)	Push “  ” button and confirm its operation.
(7)	Push “  ” button and operate normally.
(8)	Confirm its function according to the operation manual.

**DAIKIN U.S. CORPORATION**

375 Park Avenue, Suite 3308  
New York, N.Y. 10152

[info@daikinac.com](mailto:info@daikinac.com)

[www.daikinac.com](http://www.daikinac.com)