



EDUS 39 - 600 - F8

R-410A

Engineering Data

BSVQ-M
BS Units



DAIKIN AC (AMERICAS), INC.

BSVQ-M BS Units

1. Specifications	2
2. Dimensions	3
3. Piping Diagrams	4
4. Wiring Diagrams.....	5
5. Electric Characteristics.....	6
6. Installation	7
7. Accessories.....	21

1. Specifications

BS Units

Model		BSVQ36MVJU		BSVQ60MVJU		
Power Supply		60Hz 208~230V		60Hz 208~230V		
Total Capacity Index of Connectable Indoor Unit		Less than 36		Less than 60		
No. of Connectable Indoor Units		Max. 3		Max. 5		
Casing		Galvanized Steel Plate		Galvanized Steel Plate		
Dimensions: (H×W×D)		in/mm		7-1/4 × 12-1/4 × 11(184.15 × 311.15 × 279.4)		
Sound-Absorbing Thermal Insulation Material		Flame and Heat Resistant Foamed Polyethylene		Flame and Heat Resistant Foamed Polyethylene		
Piping Connection	Indoor Unit	Liquid Pipes	φ 3/8" / 9.53mm (Flare Connection) ^{★1}		φ 3/8" / 9.53mm (Flare Connection)	
		Gas Pipes	φ 5/8" / 15.88mm (Flare Connection) ^{★1}		φ 5/8" / 15.88mm (Flare Connection)	
	Outdoor Unit	Liquid Pipes	φ 3/8" / 9.53mm (Flare Connection) ^{★1}		φ 3/8" / 9.53mm (Flare Connection)	
		Suction Gas Pipes	φ 5/8" / 15.88mm (Flare Connection) ^{★1}		φ 5/8" / 15.88mm (Flare Connection)	
		Discharge Gas Pipes	φ 1/2" / 12.7mm (Flare Connection) ^{★1}		φ 1/2" / 12.7mm (Flare Connection)	
Machine Weight (Mass)		Lbs	18		18	
Standard Accessories		Installation Manual, Attached Pipe, Insulation pipe cover, Clamps		Installation Manual, Insulation pipe cover, Clamps		
Drawing No.		4D045334		4D045339		

Note:

- ★1 If the total capacity of all indoor units connected to the system is less than 24,000 Btu/h, there is a reducer pipe included in each kit to accommodate the smaller piping size.
Braze the connection between the attached pipe and field pipe.
- 2 Refer to page 6 for Power Input.

2. Dimensions

BSVQ36MVJU
BSVQ60MVJU

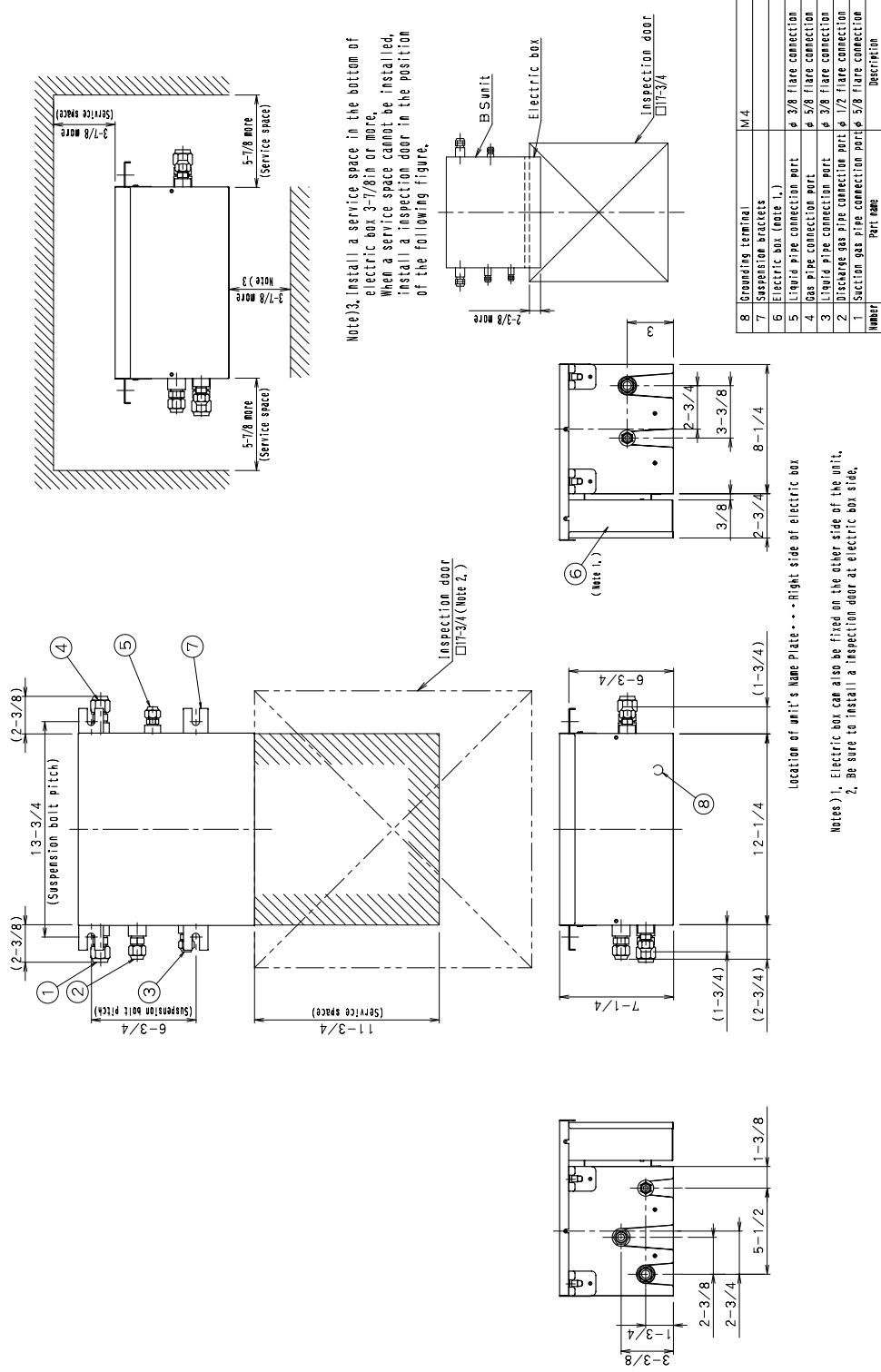

Note)3. Install a service space in the bottom of electric box 3-7/8in or more. When a service space cannot be installed, install a inspection door in the position of the following figure.

Location of unit's name plate - - - Right side of electric box
Notes) 1. Electric box can also be fixed on the other side of the unit.
2. Be sure to install a inspection door at electric box side.

NUMBER	PART NAME	DESCRIPTION
8	Grounding terminal	M 4
7	Suspension brackets	
6	Electric box (note 1.)	
5	Liquid pipe connection port	φ 3/8 flare connection
4	Gas pipe connection port	φ 5/8 flare connection
3	Liquid pipe connection port	φ 3/8 flare connection
2	Discharge gas pipe connection port	φ 1/2 flare connection
1	Section gas pipe connection port	φ 5/8 flare connection

3D045335

3. Piping Diagrams

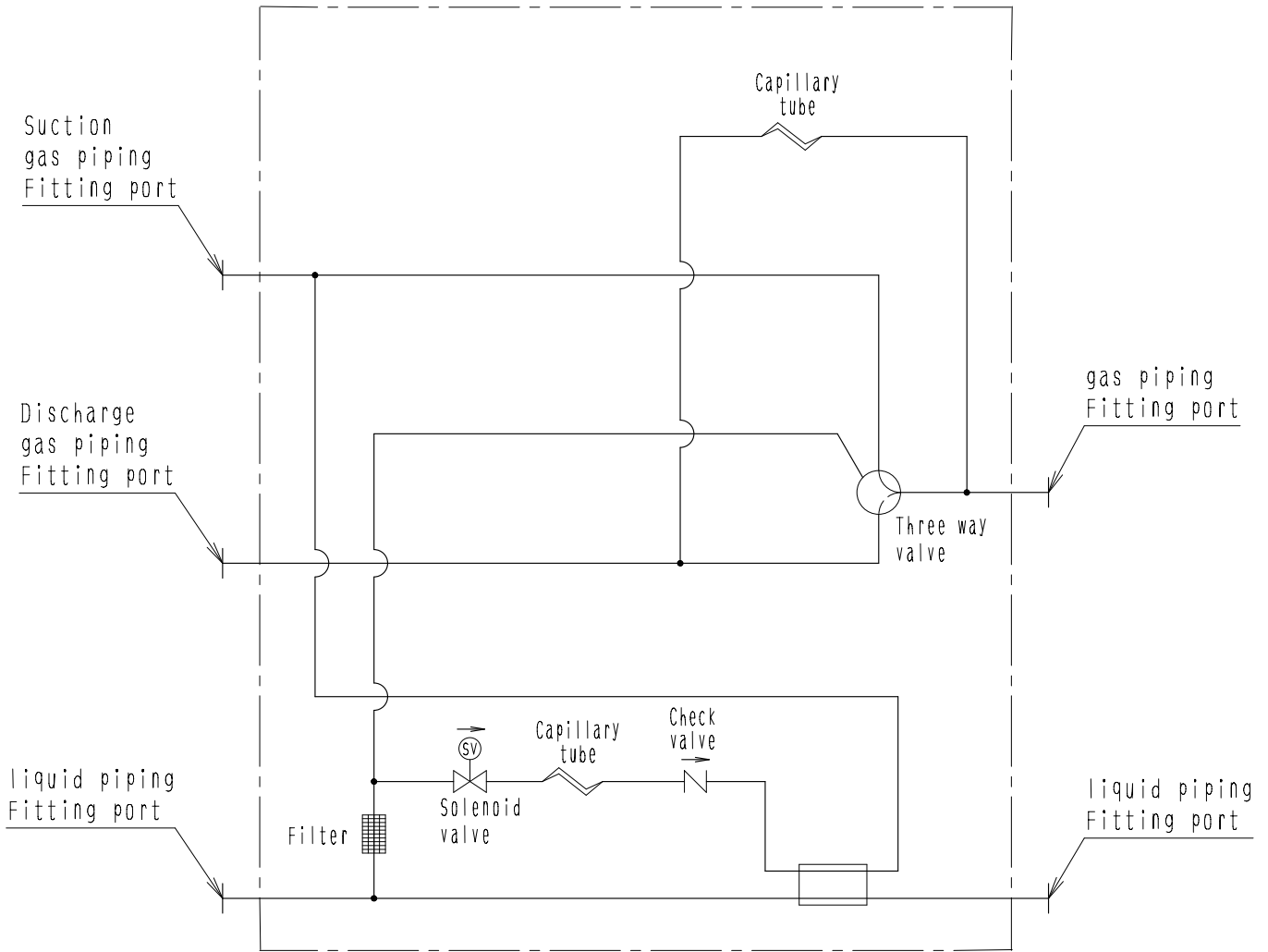

4D045338

4. Wiring Diagrams

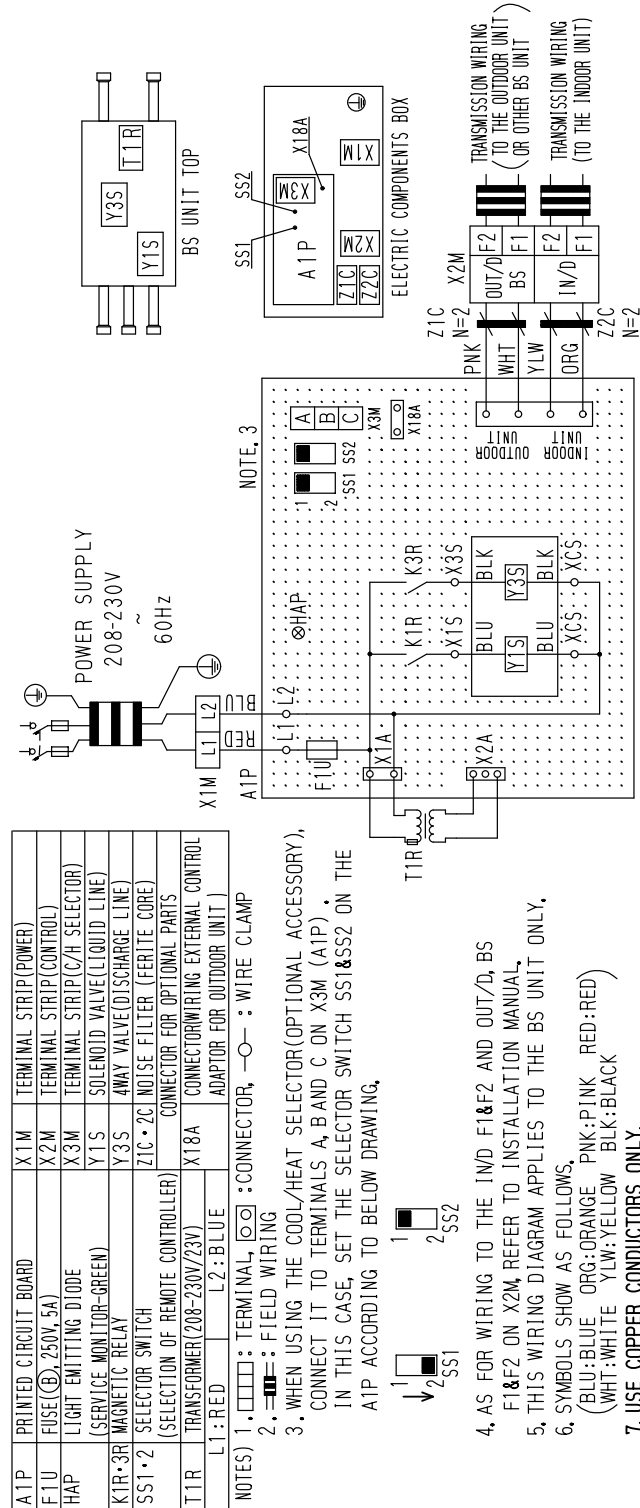

3D045069A

A1P	PRINTED CIRCUIT BOARD	X1M	TERMINAL STRIP (POWER)
F1U	FUSE (②, 250V, 5A)	X2M	TERMINAL STRIP (CONTROL)
HAP	LIGHT EMITTING DIODE (SERVICE MONITOR-GREEN)	X3M	TERMINAL STRIP (C/H SELECTOR)
K1R·3R	MAGNETIC RELAY	Y1S	SOLENOID VALVE (LIQUID LINE)
SS1·2	SELECTOR SWITCH (SELECTION OF REMOTE CONTROLLER)	Y3S	AWAY VALVE (DISCHARGE LINE)
T1R	TRANSFORMER (208-230V/23V)	Z1C·Z2C	NOISE FILTER (FERRITE CORE) CONNECTOR FOR OPTIONAL PARTS
L1: RED	L2: BLUE	X18A	CONNECTOR (WIRING EXTERNAL CONTROL ADAPTOR FOR OUTDOOR UNIT)

- NOTES) 1. □□□□ : TERMINAL, □□□□ : CONNECTOR, —○— : WIRE CLAMP
 2. □□□□ : FIELD WIRING
 3. WHEN USING THE COOL/HEAT SELECTOR (OPTIONAL ACCESSORY), CONNECT IT TO TERMINALS A, BAND C ON X3M (A1P). IN THIS CASE, SET THE SELECTOR SWITCH SS1&SS2 ON THE A1P ACCORDING TO BELOW DRAWING.
4. AS FOR WIRING TO THE IN/D F1&F2 AND OUT/D, BS F1&F2 ON X2M, REFER TO INSTALLATION MANUAL.
 5. THIS WIRING DIAGRAM APPLIES TO THE BS UNIT ONLY.
 6. SYMBOLS SHOW AS FOLLOWS, (BLU:BLUE ORG:ORANGE Pnk:PINK RED:RED) (WHT:WHITE YLW:YELLOW BLK:BLACK)
 7. USE COPPER CONDUCTORS ONLY.

5. Electric Characteristics

Units					Power supply		IFM		Input(W)	
Model	Type	Hz	Volts	Voltage range	MCA	MFA	KW	MFA	Cooling	Heating
BSVQ36M	VJ	60	208-230	MAX. 253 Min. 187	0.1	15	—	—	19	19
BSVQ60M					0.1	15	—	—	19	19

C: 4D045336

Note :

1. Voltage range
Units are suitable for use on electrical systems where voltage supplied to unit terminals is not below or above listed range limits.
2. Maximum allowable voltage unbalance between phases is 2%.
3. MCA/MFA
MCA = 1.25 X FLA
MFA ≤ 4 X FLA
(Next lower standard fuse rating. Min. 15A)
4. Select wire size based on the MCA.
5. Instead of fuse, use Circuit Breaker.

Symbols :

- MCA : Min. Circuit Amps (A)
MFA : Max. Fuse Amps (See note 5)
KW : Fan Motor Rated Output(KW)
FLA : Full Load Amps(A)
IFM : Indoor Fan Motor

6. Installation

Center of Gravity

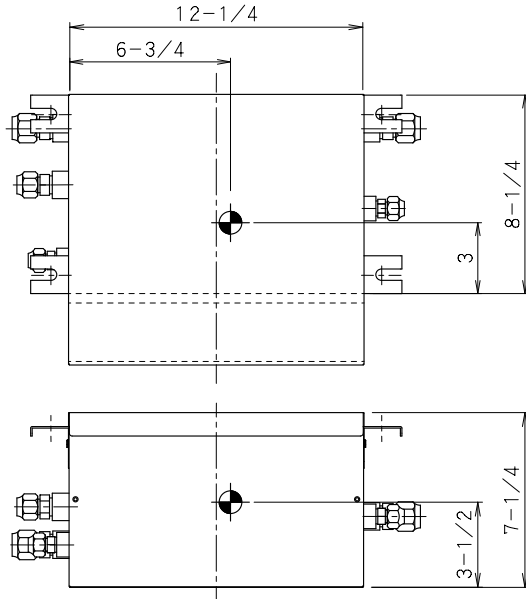

IN CASE OF THE ELECTRICAL BOX ON THE STANDARD SIDE OF THE UNIT

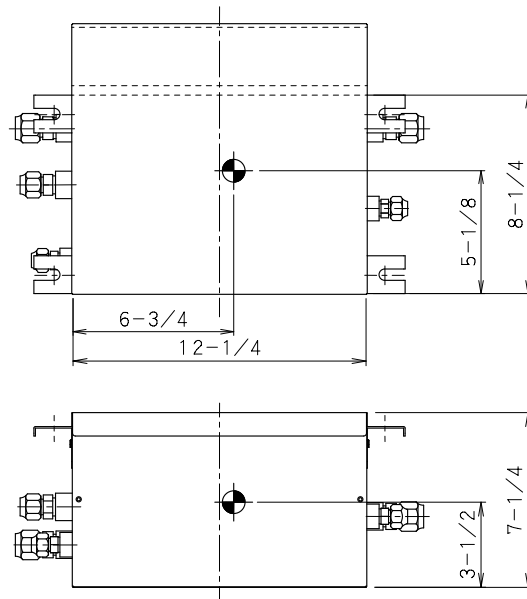

IN CASE OF THE ELECTRICAL BOX ON THE OTHER SIDE OF THE UNIT

3D045337

1. SAFETY CONSIDERATIONS

Please read these “SAFETY CONSIDERATIONS” carefully before installing air conditioning equipment and be sure to install it correctly. After completing the installation, make sure that the unit operates properly during the start-up operation.

Please instruct the customer on how to operate the unit and keep it maintained.

Also, inform customers that they should store this installation manual along with the operation manual for future reference.

This air conditioner comes under the term “appliances not accessible to the general public”.

Meaning of warning, caution and note symbols.

! **WARNING** Indication a potentially hazardous situation which, if not avoided, could result in death or serious injury.

! **CAUTION** Indication a potentially hazardous situation which, if not avoided, may result in minor or moderate injury. It may also be used to alert against unsafe practices.

! **NOTE** Indication situation that may result in equipment or property-damage-only accidents.

! **WARNING**

- **Ask your dealer or qualified personnel to carry out installation work. Do not try to install the machine by yourself.**
Improper installation may result in water leakage, electric shocks or fire.
- **Perform installation work in accordance with this installation manual.**
Improper installation may result in water leakage, electric shocks or fire.
- **When installing the unit in a small room, take measures against to keep refrigerant concentration from exceeding allowable safety limits in the event of refrigerant leakage.**
Contact the place of purchase for more information. Excessive refrigerant in a closed ambient can lead to oxygen deficiency.
- **Be sure to use only the specified accessories and parts for installation work.**
Failure to use the specified parts may result in water leakage, electric shocks, fire or the unit falling.
- **Install the air conditioner on a foundation strong enough to withstand the weight of the unit.**
A foundation of insufficient strength may result in the equipment falling and causing injuries.

- **Carry out the specified installation work after taking into account strong winds, typhoons or earthquakes.**

Improper installation work may result in the equipment falling and causing accidents.

- **Make sure that a separate power supply circuit is provided for this unit and that all electrical work is carried out by qualified personnel according to local laws and regulations and this installation manual.**

An insufficient power supply capacity or improper electrical construction may lead to electric shocks or fire.

- **Make sure that all wiring is secured, the specified wires are used, and no external forces act on the terminal connections or wires.**

Improper connections or installation may result in fire.

- **When wiring the power supply and connecting the remote controller wiring and transmission wiring, position the wires so that the electric parts box lid can be securely fastened.**

Improper positioning of the electric parts box lid may result in electric shocks, fire or the terminals overheating.

- **If the refrigerant gas leaks during installation, ventilate the area immediately.**

Toxic gas may be produced if the refrigerant gas comes into contact with fire.

- **After completing the installation work, check that the refrigerant gas does not leak.**

Toxic gas may be produced if the refrigerant gas leaks into the room and comes into contact with a source of fire, such as a fan heater, stove or cooker.

- **Before touching electrical parts, turn off the unit.**

- **Ground the air conditioner. Do not connect the ground wire to gas or water pipes, lightning rod or a telephone ground wire.**

Incomplete grounding may result in electric shocks.

- **Do not touch the switch with wet fingers.**

Touching a switch with wet fingers can cause electric shock.

- **Install an leak circuit breaker, as required.**

If an leak circuit breaker is not installed, electric shock may result.

- **Do not install the air conditioner in the following locations:**

(a) where a mineral oil mist or an oil spray or vapor is produced, for example in a kitchen Plastic parts may deteriorate and fall off or result in water leakage.

(b) where corrosive gas, such as sulfurous acid gas, is produced Corroding copper pipes or soldered parts may result in refrigerant leakage.

(c) near machinery emitting electromagnetic waves Electromagnetic waves may disturb the operation of the control system and result in a malfunction of the equipment.

(d) where flammable gases may leak, where there are carbon fiber or ignitable dust suspensions in the air, or where volatile flammables such as thinner or gasoline are handled.

Operating the unit in such conditions may result in fire.



CAUTION

- **While following the instructions in this installation manual, insulate piping in order to prevent condensation.**

Improper piping insulation may result in water leakage and property damage.

- **Be very careful about product transportation.**

Some products use PP bands for packaging. Do not use any PP bands for a means of transportation. It is dangerous.

- **Safely dispose of the packing materials.**

Packing materials, such as nails and other metal or wooden parts, may cause stabs or other injuries.

Tear apart and throw away plastic packaging bags so that children will not play with them. If children play with a plastic bag which was not torn apart, they face the risk of suffocation.

NOTE

- **Install the indoor and outdoor units, power supply wiring and connecting wires at least 3.5ft. away from televisions or radios in order to prevent image interference or noise.**
(Depending on the radio waves, a distance of 3.5ft. may not be sufficient enough to eliminate the noise.)
 - **Remote controller (wireless kit) transmitting distance can result shorter than expected in rooms with electronic fluorescent lamps. (inverter or rapid start types)**
Install the indoor unit as far away from fluorescent lamps as possible.
 - **This unit is a class A product.**
In a domestic environment this product may cause radio interference in which case the user may be required to take adequate measures.
 - **Dismantling of the unit, treatment of the refrigerant, oil and eventual other parts, should be done in accordance with the relevant local and national regulations.**
-

CAUTION

The refrigerant R-410A requires strict cautions for keeping the system clean, dry and tight.

A. Clean and dry
Foreign materials (including mineral oils such as SUNISO oil or moisture) should be prevented from getting mixed into the system.

B. Tight
R-410A does not contain any chlorine, does not destroy the ozone layer, and does not reduce the earth's protection against harmful ultraviolet radiation.
R-410A can contribute slightly to the greenhouse effect if it is released. Therefore we should take special attention to check the tightness of the installation.
Read the chapter "Refrigerant piping work" carefully and follow these procedures correctly.

2. BEFORE INSTALLATION

2-1 CAUTION CONCERNING NEW REFRIGERANT SERIES

Since R-410A is a mixed refrigerant, the required additional refrigerant must be charged in its liquid state. (If the refrigerant is charged in a state of gas, its composition changes and the system will not work properly.)

The indoor/outdoor unit is for R-410A. See the catalog for indoor/outdoor unit models which can be connected.

(Normal operation is not possible when connected to other units.)

2-2 PRECAUTIONS

- **When moving the unit while removing it from the packing case, be sure to lift it by holding on to the four hunger brackets without exerting any pressure on other parts, especially, the refrigerant piping.**
- Be sure to check the type of R-410A refrigerant to be used before installing the unit. (Using an incorrect refrigerant will prevent normal operation of the unit.)
- The accessories needed for installation must be retained in your custody until the installation work is completed. Do not discard them!
- Do not install or operate the unit in rooms mentioned below.
 - **Laden with mineral oil, or filled with oil vapor or spray like in kitchens. (Plastic parts may deteriorate which could eventually cause the unit to fall out of place, or could lead to leaks.)**
 - **Where corrosive gas like sulfurous gas exists. (Copper tubing and brazed sports may corrode, which could eventually lead to refrigerant leaks.)**
 - **Where exposed to combustible gases and where volatile flammable gas like thinner or gasoline is used. (Gas in the vicinity of the unit could ignite.)**
 - **Where machines can generate electromagnetic waves. (Control system may malfunction.)**

- Where the air contains high levels of salt such as that near the ocean and where voltage fluctuates greatly such as that in factories. Also in vehicles or vessels.
- Refer to the installation manual provided with the outdoor and the indoor unit.
If installed as a household appliance it could cause electromagnetic interference.







⚠ NOTE

- Be sure to read this manual before installing the indoor unit.
- Entrust installation to the place of purchase or a qualified serviceman. Improper installation could lead to leaks and, in worse cases, electric shock or fire.
- Use only parts provided with the unit or parts satisfying required specifications. Unspecified parts could cause the unit to fall out of place, or could lead to leaks and, in worse cases, electric shock or fire.

2-3 ACCESSORIES

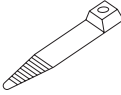
Check the following accessories are included with your unit.

<BSVQ36 · 60MVJU>

Name	1) Attached pipe			2) Clamp	3) Insulation for fitting		
Quantity	2 pcs.	1 pc.	2 pcs.	17 pcs.	2 pcs.	1 pc.	2 pcs.
Shape	1)-1 3/8" 	1)-2 1/2" 	1)-3 5/8" 		3)-1  Thin	3)-2  Medium	3)-3  Thick
	(Attached to BSVQ36MVJU only)						

FOR THE FOLLOWING ITEMS, TAKE SPECIAL CARE DURING CONSTRUCTION AND CHECK AFTER INSTALLATION IS FINISHED.

Completion check items

Check items	Problems	Check
Are the indoor, outdoor, and BS units installed securely?	Falling, vibration, and operating noise	
Have you performed a gas leak test?	Does not cool	
Is the insulation complete? (Refrigerant piping)	Water leaking	
Is the voltage the same as that listed on the unit's nameplate?	Does not operate/burnt out	
Are all the wiring and piping correct?	Does not operate/burnt out	
Is the unit grounded?	Dangers during electrical leak	
Is the thickness of the power cord as specified?	Does not operate/burnt out	
Are any obstructions blocking the indoor and outdoor units' intake and outlet vents?	Does not cool	
Have you recorded the length of the refrigerant piping and the amount of refrigerant filled?	Uncertain amount of refrigerant	

Also review the "SAFETY CONSIDERATIONS"

Hand-over check items

Check items	Check
Did you explain to the customer how to use the unit while looking at the manual?	

Important points regarding operation

In addition to general operation methods, items listed with a ⚠ WARNING or ⚠ CAUTION indicate procedures that can cause physical or property damage. You must explain them to the customer as well as having him or her read these items very carefully.

2-4 COMBINATION

- For series of applicable indoor units, refer to the technical data or other literature.
- Select the BS unit to fit the total capacity sum of the indoor units to be connected downstream. To calculate the total capacity of the indoor units, use the figure A of the table below.

Model	Total capacity sum of all downstream indoor units
BSVQ36MVJU	$A \leq 36$
BSVQ60MVJU	$36 < A \leq 60$

Capacity of indoor unit

Capacity expressed as indoor unit's model No.	12	18	24	30	36	48
Indoor unit's capacity (for use in computation): A	12	18	24	30	36	48

3. SELECTING INSTALLATION SITE

! NOTE

- Do not throw away any of the accessories until installation is complete.
- Hold the unit by the hunger brackets (4) when opening the box and moving it, and do not lift it holding on to any other part especially the refrigerant piping.
- If you think the humidity inside the ceiling might exceed 86°F and RH80%, reinforce the insulation on the inter-unit piping.
- Use glass wool or polyethylene foam as insulation so that it is no thinner than 3/8" and fits inside the ceiling opening.

(1) Select an installation site where the following conditions are satisfied and that meets with your customer's approval.

- Where is resistible against weight of BS unit.
- Where sufficient clearance for maintenance and service can be ensured.
- Where the total piping length involving indoor unit and outdoor unit is below the allowable piping length. (See installation manual attached to outdoor unit.)
- Locations where there is no possibility of flammable gas leaking.
- Locations where the wall is not significantly tilted.
- Locations where an inspection hole (see figure below) can be installed.

<BSVQ36 · 60MVJU>

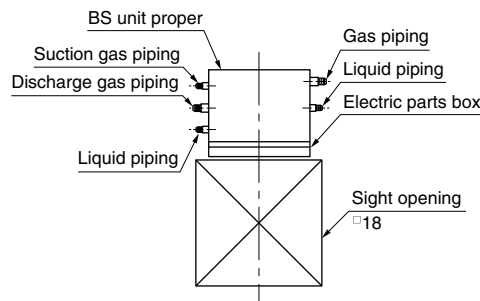
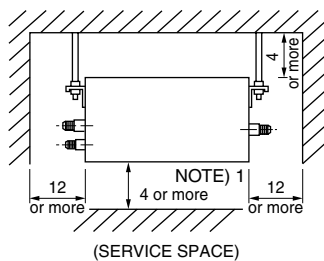

(Sight opening must be of above size and provided in front of electric parts box.)

NOTE

1. Leave 4" of service space below the electric parts box.
If this is not possible, open a service hole in the location indicated in the figure below.
2. Make sure the power, branch, and remote control wiring of the indoor, outdoor, and BS units are at least 40" away from radios and televisions. This is to prevent interference with picture and sound reception. (Interference may occur even at 40" away depending on the reception quality.)

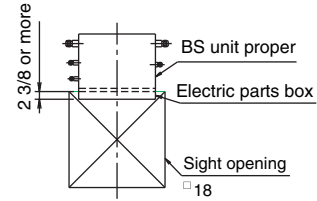

- (2) Use suspension bolts for installation. Check if the location for the installation is strong enough to support the weight of the unit, reinforce it if necessary, and install using suspension bolts.

4. PREPARATIONS BEFORE INSTALLATION

- (1) Position of suspension bolts on the BS unit.

<BSVQ36 · 60MVJU>

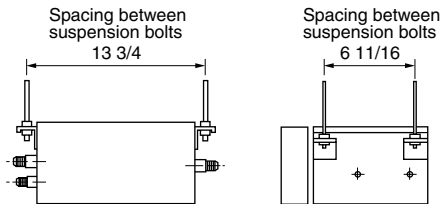

- (2) Install suspension bolts.
 - Use M8-M10 suspension bolts.
 - When holes are to be made anew, use inserts or anchor bolts. When holes are already provided, use hole-in anchors or the like. Install the BS unit so that its weight can be withstood.

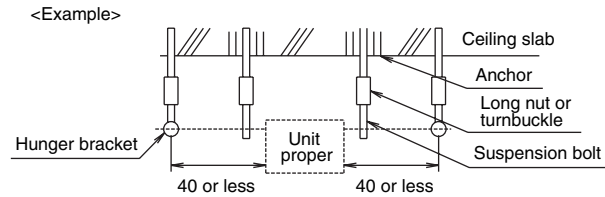

Note: All the above parts are part to be procured in the field.

- (3) Support the connection piping.
 - To prevent excessive weight from bearing on the hunger brackets of the BS unit, support the connection piping around the unit and no further away than 40" from the unit. Too much weight on the hunger brackets will cause the BS unit to drop and cause injury.

5. BS UNIT INSTALLATION

- (1) Attach the hunger brackets to the suspension bolts.
Be sure to sandwich the hunger brackets between nuts and washers, and securely fix it.

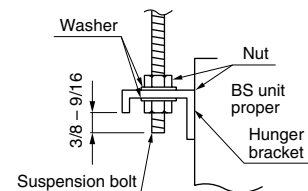

<Caution>

- The BS unit has a top and a bottom, so install it so that the diagonal lines in the figure next page are where the top is. (Failing to do so may prevent the unit from operating properly and increase the volume of the operating noise.)

- (2) The electric parts box may be installed on either side of the BS unit, as shown below.
1. Remove the electric parts box lid. (2 screws)
 2. Remove the top panel. (4 screws)
 3. Remove the electric parts box. (2 screws)
 4. Change the way the wiring between the unit and the electric parts box (transformer, two solenoid valve coils) is pulled out. (See the figure at next page.)
 5. Attach the electric parts box.
 6. Turn the top panel around 180° and attach it.
 7. Attach the electric parts box lid.

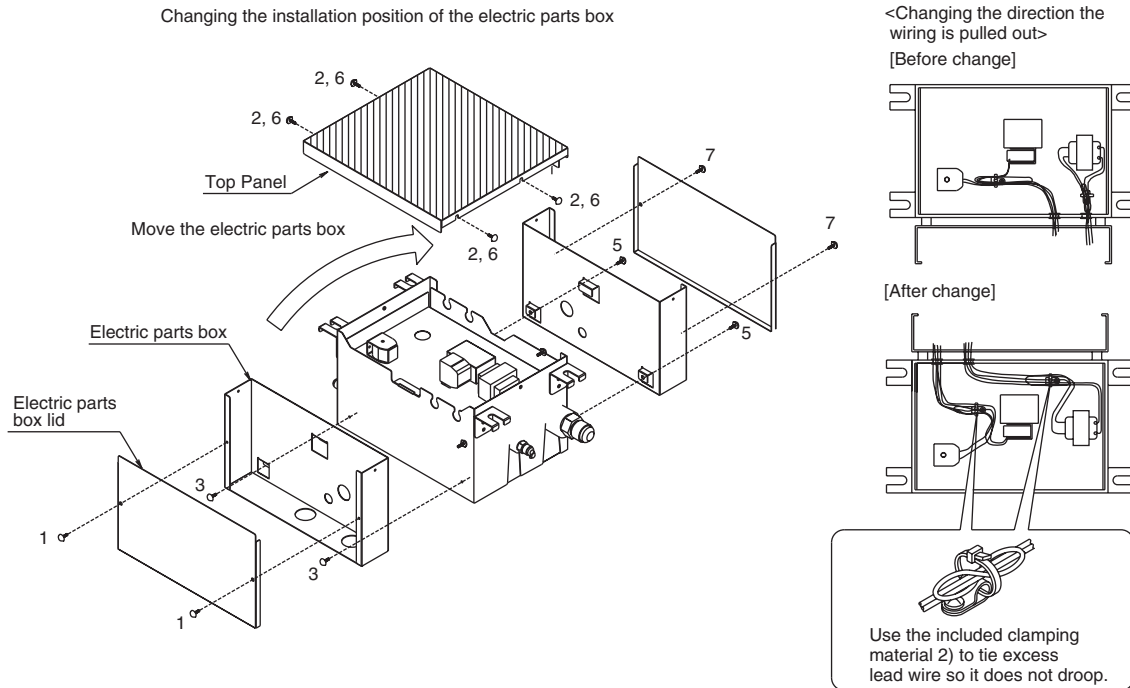

NOTE

- Install the BS unit according to the instructions shown on the name plate attached to the electric parts box.
- Clamp securely so the interior wiring does not touch the screws or sheet metal due to looseness.

6. REFRIGERANT PIPING WORK

- This section describes how to connect the piping to the BS unit. Select the piping size based on the procedure outlined here.
- Regarding piping work between the outdoor unit and the BS unit, selection of the branch kit, and the piping work between the branch kit and the indoor unit, see the installation manual for the outdoor unit and other technical documents.
- Always check that the refrigerant to be used is R-410A before starting work. (If the wrong refrigerant is used, the unit will not operate normally.)
- Completely insulate the discharge and suction piping both liquid and gas. Not insulating them may cause leaking or burns. Only use insulating material which is resistant to 250°F or higher. If you think the humidity in the ceiling might exceed 86°F and RH80%, reinforce the insulation on the cooling piping (at least 13/16" thick). Condensation might form on the surface of the insulation.

⚠ **NOTE**

- Use a pipe cutter and flare suitable for R-410A.
- Use a piping branch pipe kit selected based on the selection procedure for refrigerant branch kits.
- See the installation manual for the outdoor unit and other relevant technical documents for details on refrigerant branch kit selection, maximum piping length, maximum height difference, and maximum length after branch.
- Apply ether oil or ester oil around the flare portions before connecting.
- Only use the flare nuts included with the unit. Using different flare nuts may cause the refrigerant to leak.
- To prevent dust, moisture or other foreign matter from infiltrating the tube, either pinch the end or cover it with tape.
- The outdoor unit is charged with refrigerant.
- Be sure to use both a spanner and torque wrench together when connecting or disconnecting pipes to/from the unit. **(Refer to Fig. 2)**
- When connecting the flare nut, coat the flare both inside and outside with refrigerating machine oil and initially tighten by your hand 3 or 4 turns. **(Refer to Fig. 3)**
- Refer to the Table 1 for the measurements of tightening torque and flare. Overtightening may damage the flare.
- Refer to Table 2 if no torque wrench is available.
Using a wrench to tighten flare nuts causes the tightening torque to suddenly grow much tighter after a certain point. From there, tighten the nut further by the appropriate angle listed in Table 2. After this is done, make sure no gas is leaking.
- When brazing the refrigerant piping, perform nitrogen replacement (note 1) first or perform the brazing (note 3) while feeding nitrogen into the refrigerant piping (note 2), and finally connect the indoor unit and BS unit using the flare or flange connections.

Notes

- 1 For details on nitrogen replacement, see the “VRV Installation Manual” (available at any Daikin dealer).
 - 2 When feeding nitrogen into the pipes while doing the brazing, the pressure-reducing valve should be set to 2.9psi. **(Refer to Fig. 5)**
 - 3 Do not use a flux when brazing the refrigerant pipe joints.
Use phosphor copper brazing (B cup) which does not require flux.
(Using a chlorine flux may cause the pipes to corrode, and if it contains fluoride it may cause the refrigerant lubricant to deteriorate, adversely affecting the refrigerant piping system.)
- Piping connections should be checked for gas leaks and then, referring to Fig. 4, insulated using the included joint insulating material 3) on all liquid and gas pipes (a total of 5 locations) (Tighten both edges with clamp 2.) Use the included joint insulating material.
 - For locally procured insulation, be sure to insulate all the way to the pipe connections inside the machine. Exposed piping may cause condensation to form or burns on contact.
 - Use the following material specification for refrigerant piping:
 - (1) construction material: Phosphoric acid deoxidized seamless copper for refrigerant.
 - (2) size: Determine the proper size referring to chapter “SELECTION OF PIPE CONNECTION SIZE”
 - (3) The wall thickness of the refrigerant piping should comply with relevant local and national regulations.
 - Ventilate if refrigerant gas leaks while performing work.
 - Finally make sure there is no refrigerant gas leak. A toxic gas may be released by the refrigerant gas leaking indoor and being exposed to flames from an area heater, cooking stove, etc.

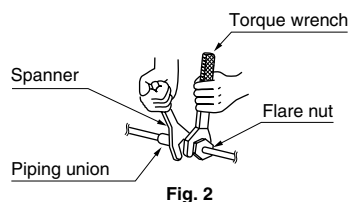

Fig. 2

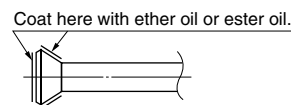

Fig. 3

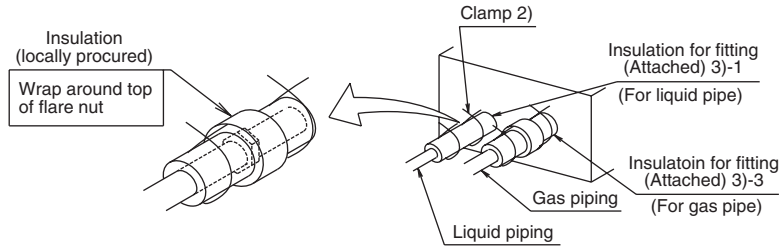

Fig. 4

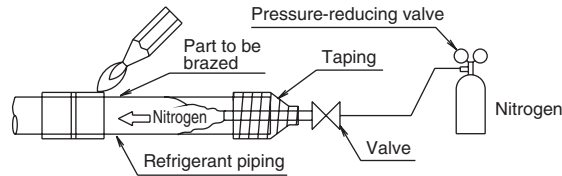

Fig. 5

Table 1

Pipe gauge (in)	Tightening torque (ft-lbf)	Flare dimension A (in)	Flare shape (in)
1/4"	10.5 – 12.7	0.343 – 0.358	
3/8"	24.1 – 29.4	0.504 – 0.520	
1/2"	36.5 – 44.5	0.638 – 0.654	
5/8"	45.6 – 55.6	0.760 – 0.776	

Table 2

Pipe size (in)	Further tightening angle (degree)	Recommended arm length of tool (in)
1/4"	60 to 90	Approx. 5 7/8"
3/8"	60 to 90	Approx. 7 7/8"
1/2"	30 to 60	Approx. 9 13/16"
5/8"	30 to 60	Approx. 11 13/16"

6-1 IN CASE OF CONNECTING ONLY ONE INDOOR UNIT

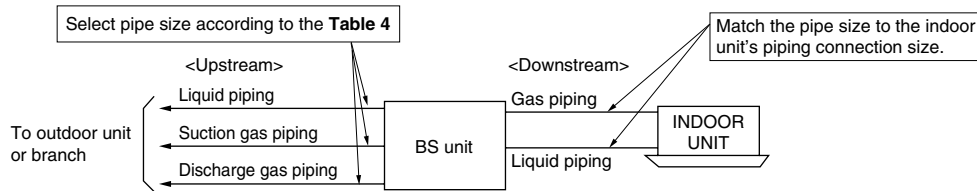

6-2 WHEN CONNECTING MULTIPLE INDOOR UNITS

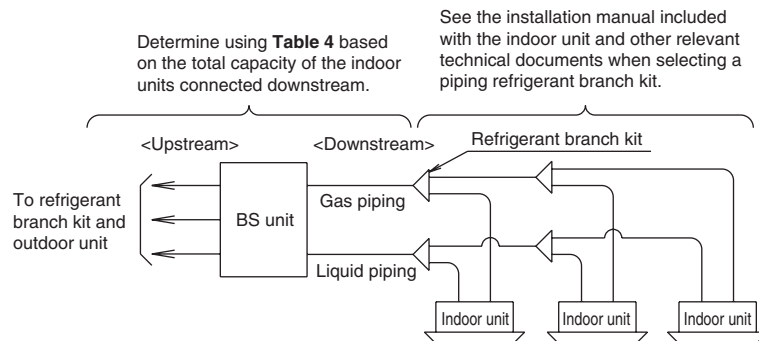

6-3 SELECTOIN OF PIPE CONNECTION SIZE

Table 3 <Indoor and BS Unit Connection Piping Sizes>

Target unit		Piping size (outer diameter) (in)	
		Gas pipe	Liquid pipe
Indoor unit's model No.	12, 18	1/2	1/4
	24, 30, 36, 48	5/8	3/8
BS unit	BSVQ36MVJU	5/8	3/8
	BSVQ60MVJU		

Note: The piping size for the BS unit indicates the size of the connection side with the indoor unit.

Table 4 < Selection of Piping Size Based on Total Capacity of Indoor Unit >

Total capacity of indoor units [×10 ³ Btu/h]	Piping size (outer diameter) (in)				
	Upstream			Downstream	
	Suction gas pipe	Discharge gas pipe	Liquid pipe	Gas pipe	Liquid pipe
Up to 24	1/2	3/8	1/4	1/2	1/4
24 or more and less than 60	5/8	1/2	3/8	5/8	3/8

See the section on “2-4 COMBINATION” at page 4 for details on indoor unit capacity.

6-4 PIPING CONNECTION

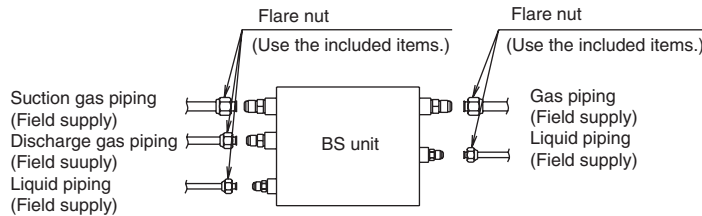

If the total capacity of the Q36-type indoor units downstream is less than 24

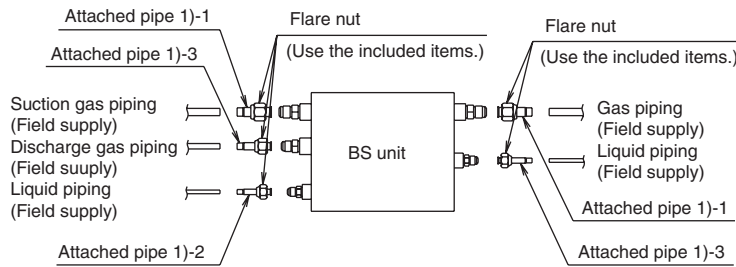

7. ELECTRIC WIRING WORK

7-1 GENERAL INSTRUCTIONS

- All field supplied parts and materials, electric works must conform to local codes.
- Use copper wire only.
- Follow the “WIRING DIAGRAM” attached to the unit body to wire the outdoor unit and indoor units.
- All wiring must be performed by an authorized electrician.
- This system consists of multiple BS units. Mark each BS unit as unit A, unit B . . . , and be sure the terminal board wiring to the outdoor unit and indoor unit are properly matched. If wiring and piping between the outdoor unit, BS unit and an indoor unit are mismatched, the system may cause a malfunction.
- A circuit breaker capable of shutting down the power supply to the entire system must be installed.
- Always ground wires. (In accordance with national regulations of the pertinent country.)

- Do not let the ground wire come in contact with gas pipes, water pipes, lightning rods, or telephone ground wires.
 - Gas pipes: gas leaks can cause explosions and fire.
 - Water pipes: cannot be grounded if hard vinyl pipes are used.
 - Telephone ground wires and lightning rods: the ground potential when struck by lightning gets extremely high.
- Do not turn on the power supply (branch switches, overload interrupters) until all other work is done.

7-2 EXAMPLE FOR THE WHOLE SYSTEM

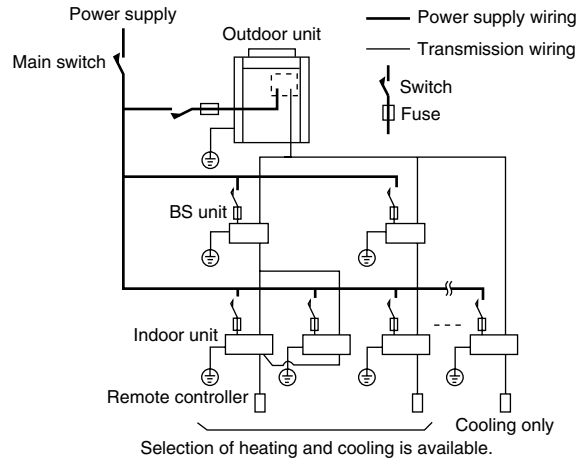

7-3 ELECTRICAL CHARACTERISTICS

Model	Type	Hz	Units			Power supply	
			Voltage	Min.	Max.	MCA	MFA
BSVQ36M BSVQ60M	VJ	60	230	187	253	0.2	15

MCA: Min. Circuit Amps (A); MFA: Max. Fuse Amps (A)

NOTE

- The above Table of Electrical Characteristics refers to the BS unit only.
- See the technical documents for other details.

7-4 SPECIFICATIONS FOR FIELD SUPPLIED FUSES AND WIRE

Model	Power supply wiring		Transmission wiring	
	Field fuse	Size	Wire	Size
BSVQ36M BSVQ60M	15A	Size must comply with local codes.	Sheathed wire (2 wire) (NOTE 2)	AWG18-16

NOTES

1. Select the particular size of electric wire for power line in accordance with the standards of the given nation and region.
2. Insulated thickness: 1/16" or more
3. Allowable length of the transmission wiring should be as follows.
 - Between outdoor unit, BS unit and indoor unit: Max. 3280ft (Total wiring length: 6560ft)
 - Between BS unit and remote controller: Max. 1640ft
 - Max. branches No. of branches: 16
4. Up to 16 branches are possible for unit-to-unit cabling. No branching is allowed after branching.

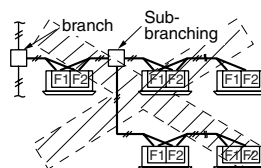

7-5 GIST OF FIELD LINE CONNECTION

• Remove the side cover of the electric parts box shown in the below figure and connect each wire.

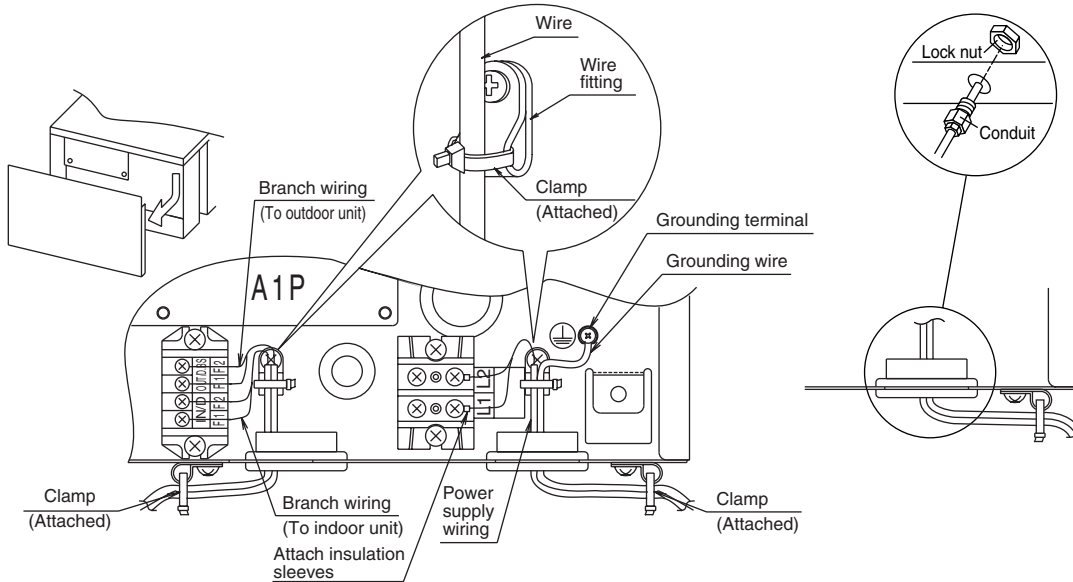

NOTE

- Keep transmission wiring a minimum of 2" from other electric wires so as to avoid the effects of external noise. (Bundle transmission wiring separate of other wires, with the included tie-wrap.)
- Do not connect power wiring to the transmission wiring terminal. Doing so could damage the entire system.
- Clamp power wiring and the grounding wire together with the included clamp.
- When clamping wiring, use the included clamping material 2) to prevent outside pressure being exerted on the wiring connections and clamp firmly. When doing the wiring, make sure the wiring is neat and does not cause the electric parts box lid to stick up, then close the cover firmly. When attaching the electric parts box lid, make sure you do not pinch any wires. To prevent the wires from damaging, be sure to pass all wires through the wiring guide.
- After wiring work is complete, block all gaps in the holes for passing out wiring using sealing material (locally procured). (This is to prevent insects from entering the machine.)

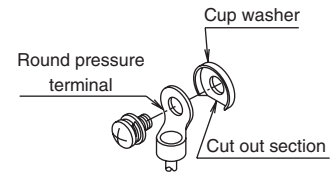

PRECAUTIONS

1. Use ring-type crimp-style terminals for connecting wires to the power supply terminal board. If unavailable, observe the following points when wiring.

- Do not connect wires of different gauge to the same power supply terminal. (Looseness in the connection may cause overheating.)
- When connecting wires of the same gauge, connect them according to the righthand figure.
- Use the specified electric wire. Connect the wire securely to the terminal. Lock the wire down without applying excessive force to the terminal.
- Use an appropriate screwdriver for tightening the terminal screws. A screwdriver with a small head will strip the head and make proper tightening impossible.
- Over-tightening the terminal screws may break them.
- See the following table for the tightening torque of the terminal screws.

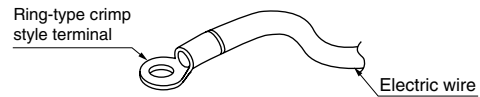

Connect wires of the same gauge to both sides. Do not connect wires of the same gauge to one side. Do not connect wires of different gauges.

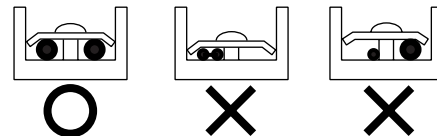

	Tightening torque (ft-lbf)
Remote controller/branch wiring terminal block (4P)	0.58~0.72
Power supply terminal block (2P)	0.87~1.06
Grounding wire	1.12~1.37

2. Do not connect wires of different gauge to the same grounding terminal. Looseness in the connection may deteriorate protection.
3. Keep transmission wiring at least 2" away from power supply wiring. The equipment may malfunction if subjected to electrical (external) noise.
4. For remote controller wiring, refer to the "INSTALLATION MANUAL OF REMOTE CONTROLLER" attached to the remote controller.
5. Never connect power supply wiring to the terminal board for transmission wiring. A mistake of the sort could damage the entire system.
6. Use only specified wire and tightly connect wires to terminals. Be careful wires do not place external stress on terminals. Keep wiring in neat order and so as not to obstruct other equipment such as popping open the service cover. Make sure the cover closes tight. Incomplete connections could result in overheating, and in worse case, electric shock or fire.
7. Use 2-core wires for branch wiring.
When wiring more than 2 indoor units and a remote controller with the same 3-core wire (or other multi-core wire), units sometimes stop unexpectedly because of trouble.
(3-core wires can be used only for the cool/heat selector)
8. Connect the cooling unit to pins F1 and F2 (outdoor unit) in the final BS unit.

EXAMPLE OF TRANSMISSION LINE CONNECTION

- Example of connecting transmission wiring.
Connect the transmission wirings as shown in the Fig. 1.

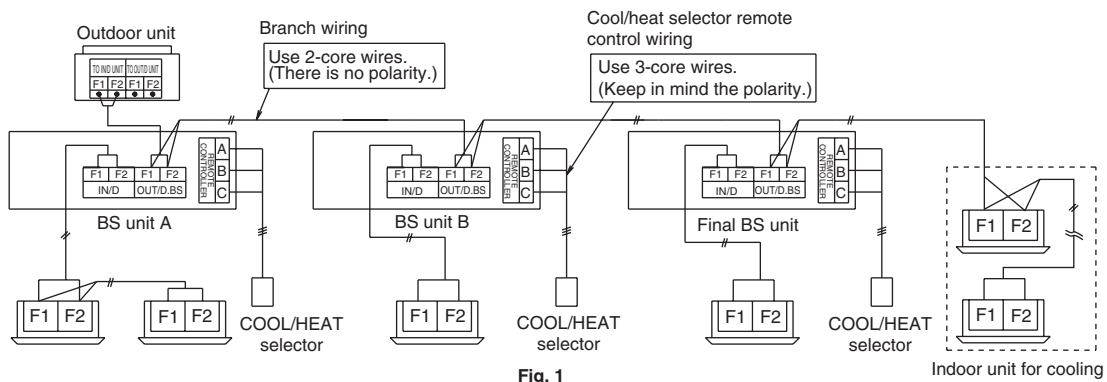
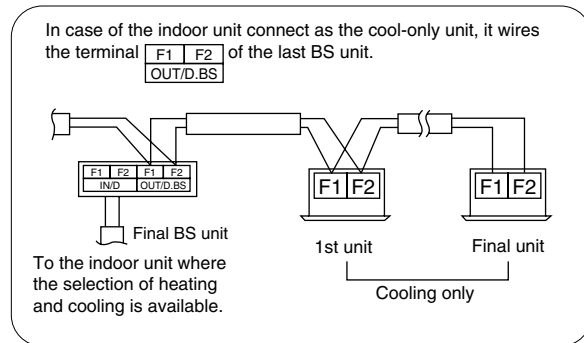

Fig. 1

7-6 INITIAL SETTING

After finishing wiring work, set the followings if necessary.

1. COOL/HEAT temperature difference setting switch (Set indoor unit remote controller to field setting mode.)

- Used to change the temperature difference upon occurrence of which to start cooling and heating in the automatic COOL/HEAT mode.

Settings are made from the remote controller of the indoor unit connected to the BS unit. The unit must be in "Field setting mode". Make settings as explained in "Field setting" (provided with the remote controller).

Mode No.	First code No.	Second code No.	COOL/HEAT temperature difference (°F)
12 (22)	4	1	0
		2	1.8
		3	3.6
		4	5.4
		5	7.2
		6	9.0
		7	10.8
		8	12.6

The first and second code Nos. are set to 1 and 0°F respectively when the unit is shipped for the factory.

2. Remote controller change over switch (SS1, SS2)

- When using COOL/HEAT selector, turn this switch to the BS side.



NOTE: This setting must be completed before turning power supply ON.

When using cool/heat selector, connect to the terminal A, B and C on the EC of the electric parts box.

8. TEST OPERATION





Refer to the installation manual of the outdoor unit.

- The operation lamp of the remote controller connected to the indoor unit will flash when an error occurs. Check the error code on the liquid crystal display to identify the point of trouble. An explanation of error codes and the corresponding trouble is provided in "CAUTION FOR SERVICING" of the indoor unit.

7. Accessories

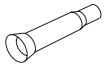
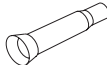
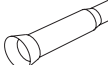
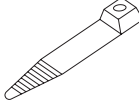
Standard Accessories

Check the following accessories are included with your unit.

Name	1) Attached pipe			2) Clamp	3) Insulation for fitting		
Quantity	2 pcs.	1 pc.	2 pcs.	17 pcs.	2 pcs.	1 pc.	2 pcs.
Shape	1)-1 3/8" 	1)-2 1/2" 	1)-3 5/8" 		3)-1  Thin	3)-2  Medium	3)-3  Thick
	(Attached to BSVQ36MVJU only)						

Optional Accessories (For Unit)

No.	Name of Options	BSVQ36MVJU	BSVQ60MVJU
1	Cool / Heat Selector		KRC19-26A
1-1	Fixing Box		KJB111A

Warning



- Daikin Industries, Ltd.'s products are manufactured for export to numerous countries throughout the world. Daikin Industries, Ltd. does not have control over which products are exported to and used in a particular country. Prior to purchase, please therefore confirm with your local authorized importer, distributor and/or retailer whether this product conforms to the applicable standards, and is suitable for use, in the region where the product will be used. This statement does not purport to exclude, restrict or modify the application of any local legislation.
- Ask a qualified installer or contractor to install this product. Do not try to install the product yourself. Improper installation can result in water or refrigerant leakage, electrical shock, fire or explosion.
- Use only those parts and accessories supplied or specified by Daikin. Ask a qualified installer or contractor to install those parts and accessories. Use of unauthorized parts and accessories or improper installation of parts and accessories can result in water or refrigerant leakage, electrical shock, fire or explosion.
- Read the User's Manual carefully before using this product. The User's Manual provides important safety instructions and warnings. Be sure to follow these instructions and warnings.

If you have any inquiries, please contact your local importer, distributor and/or retailer.



© 2004 Daikin Industries, Limited.

Daikin®, Daikin AC™, Absolute Comfort™, VRV® and REFNET™ are trademarks pending or registered trademarks of Daikin Industries, Limited. All rights reserved. LonWorks® and LON® are registered trademarks of Echelon Corporation. BACnet® is a Data Communication Protocol for Building Automation and Control Networks, developed under the auspices of the American Society of Heating, Refrigerating and Air-Conditioning Engineers (ASHRAE).



JMI-0107



JQA-1452

About ISO9001

ISO 9001 is a plant certification system defined by the International Organization for Standardization (ISO) relating to quality assurance. ISO 9001 certification covers quality assurance aspects related to the "design, development, manufacture, installation, and supplementary service" of products manufactured at the plant.



EC99J2044



JQA-E-90108

About ISO 14001

ISO 14001 is the standard defined by the International Organization for Standardization (ISO) relating to environmental management systems. Our group has been acknowledged by an internationally accredited compliance organisation as having an appropriate programme of environmental protection procedures and activities to meet the requirements of ISO 14001.

Dealer

DAIKIN AC (AMERICAS), INC.
1645 Wallace Drive, Suite 110
Carrollton, TX75006
info@daikinac.com
www.daikinac.com

©All rights reserved

● Specifications, designs and other content appearing in this brochure are current as of May 2007 but subject to change without notice.